

# Gateway®



## **User Guide**

Gateway M405 Notebook



# Contents

<b>1</b>	<b>Getting Help</b> .....	<b>1</b>
	Gateway Web site .....	3
	Using eSupport .....	4
	Help and Support .....	5
	Searching for a topic .....	6
	Using Your Computer guide .....	6
	Online help .....	7
<b>2</b>	<b>Checking Out Your Gateway Notebook</b> .....	<b>9</b>
	Front .....	10
	Left Side .....	11
	Right Side .....	13
	Back .....	14
	Bottom .....	15
	Keyboard area .....	16
	Identifying your model .....	18
	Gateway model and serial number .....	18
	Gateway serial number .....	18
	Internal wireless label .....	19
	Microsoft Certificate of Authenticity .....	19
	Finding your specifications .....	20
	Accessories .....	21
<b>3</b>	<b>Getting Started</b> .....	<b>23</b>
	Connecting the AC adapter .....	24
	Protecting from power source problems .....	26
	Starting your notebook .....	27
	Waking up your notebook .....	28
	Turning off your notebook .....	28
	Restarting (rebooting) your notebook .....	29
	Status indicators .....	30
	Using the keyboard .....	32
	Key types .....	33
	System key combinations .....	34
	Multi-function buttons .....	36
	Using the EZ Pad touchpad .....	37
	Using the touchpad .....	39
	Adjusting the volume .....	40

Turning your wireless network on or off .....	41
<b>4 Using Drives and Ports .....</b>	<b>43</b>
Using the CD or DVD drive .....	44
Identifying drive types .....	44
Inserting a CD or DVD .....	45
Playing a CD .....	46
Playing a DVD .....	46
Creating CDs and DVDs .....	46
Using the optional diskette drive .....	47
Using the optional memory card reader .....	48
Memory card types .....	48
Using a memory card .....	49
Adding and removing a PC Card .....	50
Viewing the display on a projector or monitor .....	53
<b>5 Managing Power .....</b>	<b>55</b>
Monitoring the battery charge .....	56
Recharging the battery .....	58
Recalibrating the battery .....	59
Changing batteries .....	60
Replacing the battery .....	60
Extending battery life .....	62
Conserving battery power .....	62
Using alternate power sources .....	63
Changing power modes .....	63
<b>6 Upgrading Your Notebook .....</b>	<b>65</b>
Preventing static electricity discharge .....	66
Adding or replacing memory .....	67
Replacing the hard drive kit .....	70
<b>7 Using the Optional Port Replicator .....</b>	<b>75</b>
Front .....	76
Left .....	77
Back .....	78
Connecting to the port replicator .....	80
Attaching to the port replicator .....	80
Disconnecting from the port replicator .....	81
Securing your port replicator .....	82

<b>8</b>	<b>Maintaining Your Notebook</b>	<b>83</b>
	Caring for your notebook	84
	Cleaning your notebook	85
	Cleaning the exterior	85
	Cleaning the keyboard	86
	Cleaning the notebook screen	86
	Cleaning CDs or DVDs	86
	Protecting your notebook from viruses	87
	Updating Windows	90
	Restoring your system	90
<b>9</b>	<b>Troubleshooting</b>	<b>91</b>
	Safety guidelines	92
	First steps	93
	Troubleshooting	94
	Audio	94
	Battery	94
	CD drives	94
	Device installation	94
	Diskette drive	95
	Display	96
	DVD drives	97
	File management	99
	Hard drive	99
	Internet	101
	Keyboard	102
	Memory	103
	Memory card reader	103
	Modem (dial-up)	104
	Mouse	107
	Networks	108
	Passwords	108
	PC Cards	109
	Power	109
	Printer	109
	Sound	111
	Touchpad	112
	Video	112
	Telephone support	113
	Before calling Gateway Customer Care	113
	Telephone numbers	114

<b>A Safety, Regulatory, and Legal Information .....</b>	<b>115</b>
<b>Index .....</b>	<b>127</b>

# Chapter 1

---

## Getting Help



- Using the Gateway Web site
- Using Help and Support
- Using Your Computer guide
- Using online help

# Thank you for purchasing our notebook!

You have made an excellent decision choosing Gateway. We are sure that you will be pleased with the outstanding quality, reliability, and performance of your new notebook. Each and every Gateway notebook uses the latest technology and passes through the most stringent quality control tests to ensure that you are provided with the best product possible.

Your new Gateway notebook is designed to provide an exceptional balance of performance and portability. Your notebook uses the latest chipset and mobile processor technologies to manage the processor speed and power consumption for a greater battery life experience. This design provides you with maximum performance when plugged into AC power balanced with optimized battery life when on battery power.

Please read this manual carefully to familiarize yourself with our range of services and support. We have highlighted some basic care and safety information to help you keep your notebook in good operating condition.

Gateway stands behind our value proposition to our customers — to provide best-of-class service and support in addition to high-quality, brand-name components at affordable prices. If you ever have a problem, our knowledgeable, dedicated customer service department will provide you with fast, considerate service.

We sincerely hope that you will receive the utmost satisfaction and enjoyment from your new Gateway notebook for years to come.

Thank you again, from all of us at Gateway.



# Gateway Web site

Gateway's online support is available 24 hours per day, 7 days per week and provides the most current drivers, product specifications, tutorials, and personalized information about your notebook. Visit the Gateway eSupport Web site at [support.gateway.com](http://support.gateway.com).



# Using eSupport

The eSupport site is divided into five major areas:

- Support Home
- Product Support
- Downloads
- Contact Us
- PC Tools

## Support Home

Click **Support Home**, then click **All Support Documents** to access product documentation, specifications, and guides. You can also browse through the reference area to locate an article specific to the question you have.

Click **Support Home**, then click **General Tutorials** to access an extensive library of how-to articles and videos on topics, such as making audio CDs and installing a hard drive.

## Product Support

Click **Product Support** to view a list of all the products that Gateway supports.

## Downloads

Click **Downloads**, then click **My Downloads** to get the latest software updates for BIOS and driver upgrades. By entering your serial number you get drivers specific to your notebook. Click **All Downloads** to walk through a step-by-step wizard to locate your drivers.

## Contact Us

Click **Contact Us** to access links to customer care with a live technician, including chat and e-mail. Click **Call Us** to get a list of Gateway telephone numbers for both sales and support. For more information, see [“Telephone support” on page 113](#).

## PC Tools

Click **PC Tools** to access utilities to help you manage your notebook.

# Help and Support

Your notebook includes *Help and Support*, an easily accessible collection of help information, troubleshooters, and automated support. Use Help and Support to answer questions about Windows and to help you quickly discover and use the many features of your Gateway notebook.

## ▶ To start Help and Support:

- Click **Start**, then click **Help and Support**. Help and Support opens.

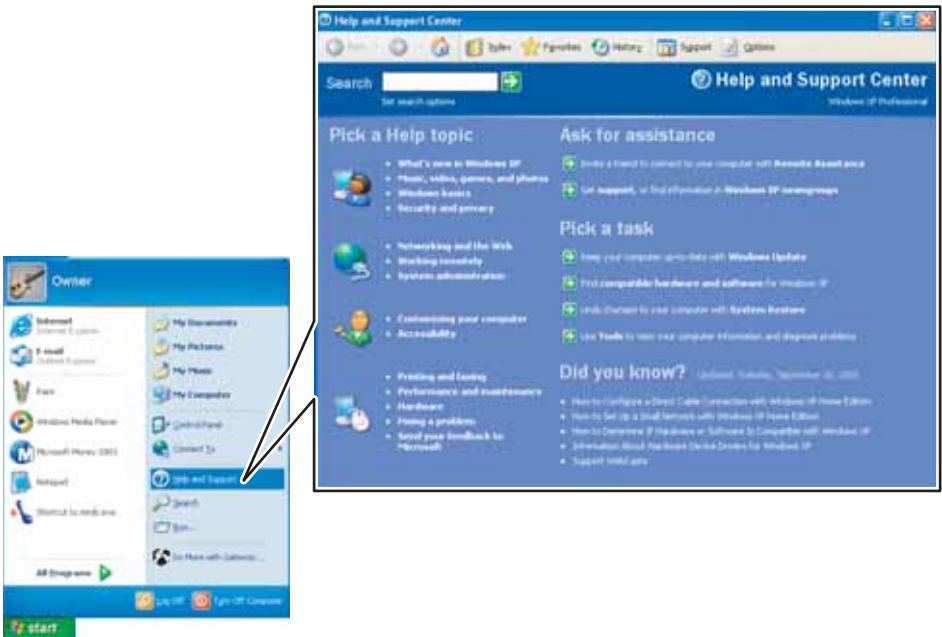

You can find help information by clicking a link, performing a search, or browsing the index.

## Searching for a topic

To search for a topic in Help and Support, type a word or phrase (keyword) in the **Search** box located at the top of any Help and Support screen, then click the arrow  button.

For each search, you receive the following search result types:

- Suggested Topics - These topics are located in Help and Support and are relevant to your search topic.
- Full-text Search Matches - These topics are located in Help and Support and contain the words you entered in the **Search** box.
- Microsoft Knowledge Base - These topics are located on the Microsoft Web site and contain the words you entered in the **Search** box. You must be connected to the Internet to search for and access these topics.

To view a list of your search results, click the results header for the type of results you want to view.

To view a topic, click the topic name in the **Search Results** list.

## Using Your Computer guide

In addition to this guide, the *Using Your Computer* guide has been included on your hard drive. This guide includes information on using Windows, using the Internet, sending a fax, and changing power-saving settings as well as other topics.

### To access the **Using Your Computer** guide:

- Click **Start**, **All Programs**, then click **Gateway Documentation**.



# Online help

Many programs provide information online so you can research a topic or learn how to perform a task while you are using the program. You can access most online help information by selecting a topic from a **Help** menu or by clicking a **Help** button.



You can search for information by viewing the help contents, checking the index, searching for a topic or keyword, or browsing through the online help.

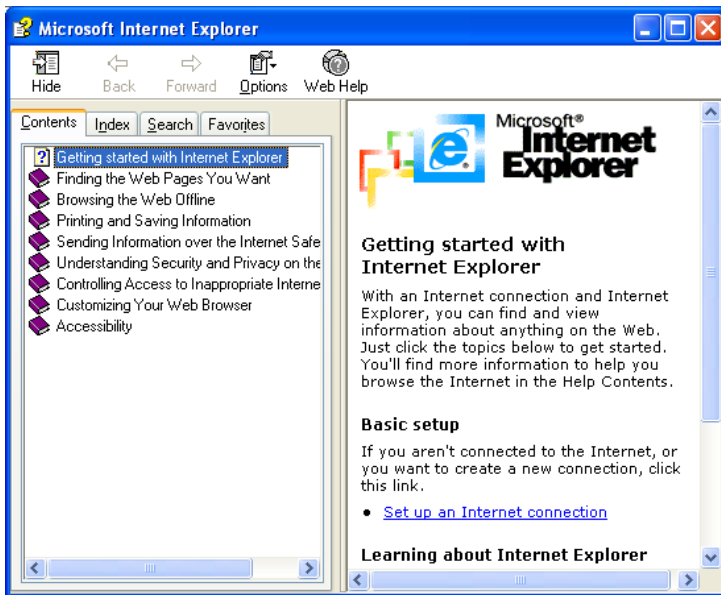



# Chapter 2

---



## Checking Out Your Gateway Notebook



- Identifying features
- Locating your notebook's model and serial number
- Locating the Microsoft Certificate of Authenticity
- Locating the specifications for your notebook
- Purchasing accessories

# Front







Component	Icon	Description
Speakers		Provide audio output when headphones or amplified speakers are not plugged in.
Battery charge indicator		The LED shows the battery activity and status. <ul style="list-style-type: none"><li>▪ LED green - battery is fully charged.</li><li>▪ LED orange - battery is charging.</li><li>▪ LED blinking red - battery charge is very low.</li><li>▪ LED solid red - battery is malfunctioning.</li></ul> This LED only lights up when your notebook is connected to AC power or the battery charge is very low.
Power indicator		The LED shows your notebook's power status. <ul style="list-style-type: none"><li>▪ LED on - notebook is on.</li><li>▪ LED blinking - notebook is in Standby mode.</li><li>▪ LED off - notebook is off.</li></ul>
LCD panel release latch		Open the LCD panel by pressing the release latch.

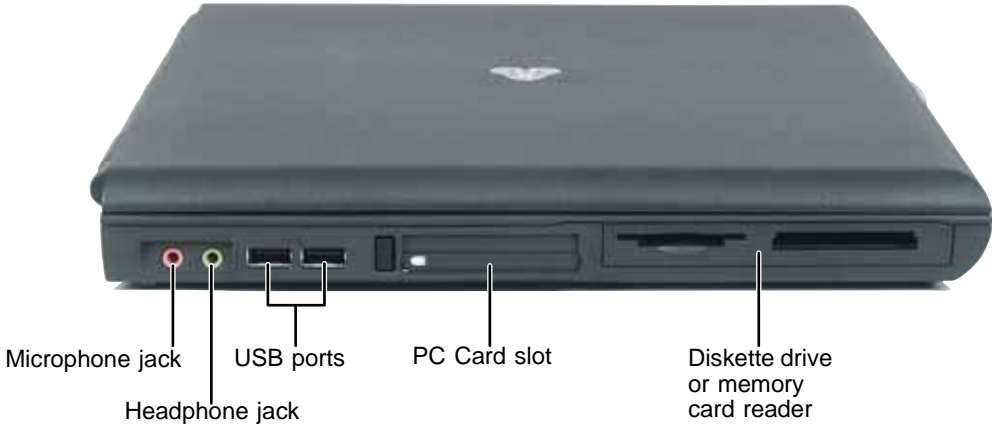

# Left Side



Component	Icon	Description
Microphone jack		Plug a microphone into this jack.
Headphone jack		Plug amplified speakers or headphones into this jack. The built-in speakers are turned off when speakers or headphones are plugged into this jack.
USB ports		Plug USB (Universal Serial Bus) devices (such as a diskette drive, flash drive, Iomega™ Zip™ drive, printer, scanner, camera, keyboard, or mouse) into these ports.
PC Card slot		Insert one Type II or one Type III PC Card into this slot. For more information, see <a href="#">“Adding and removing a PC Card”</a> on page 50.

---

Component	Icon	Description
Diskette drive or memory card reader		<p data-bbox="423 161 975 240">Insert a standard 3.5-inch diskette into the optional diskette drive. For more information, see <a href="#">“Using the optional diskette drive” on page 47</a>.</p> <p data-bbox="423 256 1009 368">Insert a memory card from a digital camera, MP3 player, PDA, or cellular telephone into the optional memory card reader. For more information, see <a href="#">“Using the optional memory card reader” on page 48</a>.</p> <p data-bbox="423 384 1009 584"><b>Important:</b> Your notebook comes with either a built-in diskette drive or a built-in memory card reader. If your notebook has a built-in memory card reader and you need to use a diskette drive, Gateway recommends purchasing a USB diskette drive. To order a USB diskette drive, visit the Accessory Store at <a href="http://accessories.gateway.com">accessories.gateway.com</a>.</p>

---





# Right Side

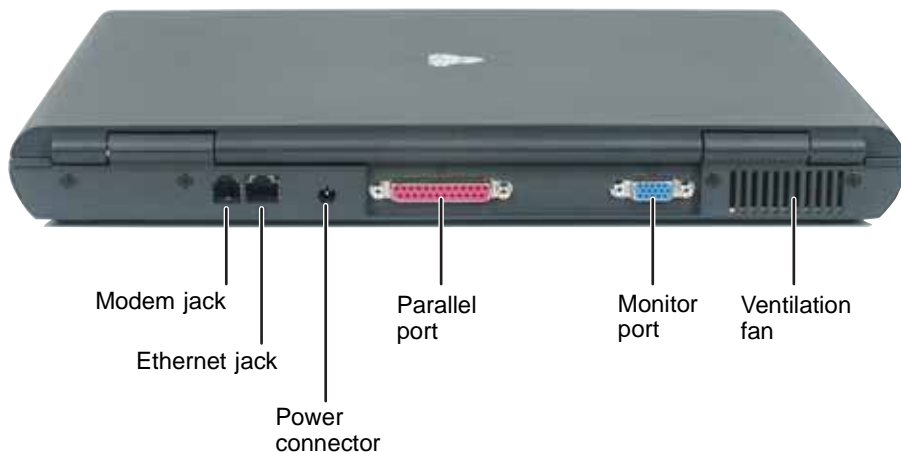

Component	Icon	Description
CD, DVD, DVD/CD-RW, or recordable DVD drive		<p>Insert CDs or DVDs into this drive. For more information, see <a href="#">“Using the CD or DVD drive” on page 44.</a></p> <p>This drive may be a CD, DVD, combination DVD/CD-RW, or recordable DVD drive. To determine the type of drive in the notebook, examine the drive tray’s plastic cover and compare the logo to those listed in <a href="#">“Identifying drive types” on page 44.</a></p>
Kensington™ lock slot		Secure your notebook to an object by connecting a Kensington cable lock to this slot.

# Back



Component	Icon	Description
Modem jack		Plug a modem cable into this jack.
Ethernet jack		Plug a 10/100 Ethernet network cable into this jack.
Power connector		Plug the AC adapter cable into this connector.
Parallel port		Plug a parallel device (such as a printer) into this port.
Monitor port		Plug an analog VGA monitor or projector into this port. For more information, see <a href="#">“Viewing the display on a projector or monitor” on page 53.</a>
Ventilation fan		Helps cool internal components. Do not block or insert objects into these slots.

# Bottom

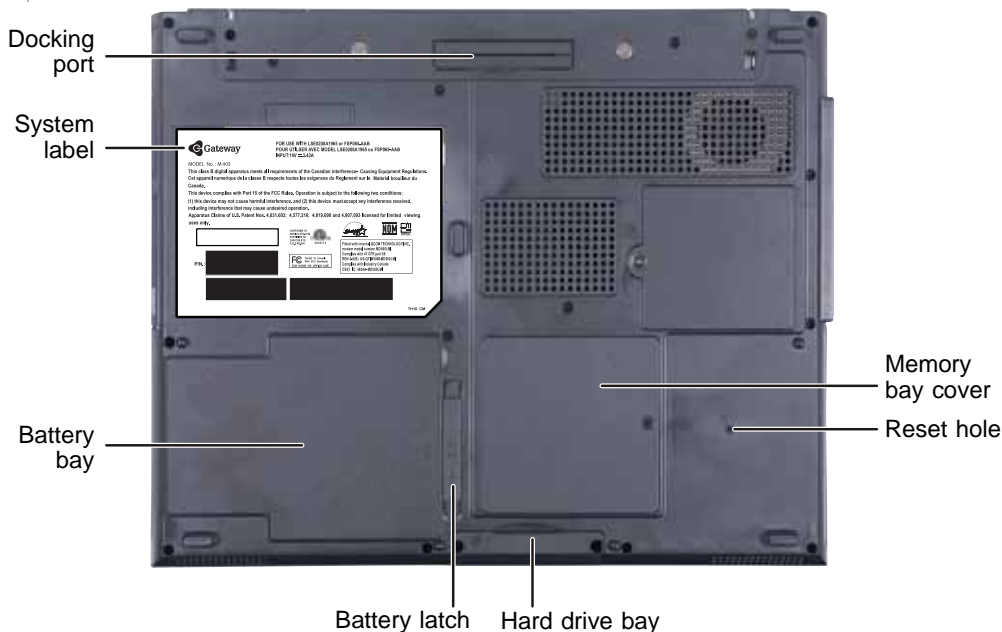



Component	Icon	Description
Memory bay		Install as many as two memory modules into this bay. For more information, see <a href="#">“Adding or replacing memory” on page 67.</a>
Reset hole		Insert a straightened paper clip into this hole to manually restart the notebook.
Hard drive bay		The hard drive is located in this bay. For more information, see <a href="#">“Replacing the hard drive kit” on page 70.</a>
Battery latch		Slide to release the battery.
Battery bay		Insert the battery into this bay. For more information, see <a href="#">“Changing batteries” on page 60.</a>

Component	Icon	Description
System label		Includes the product model number. For more information, see <a href="#">“Identifying your model” on page 18.</a>
Docking port		Connect the port replicator to this port. <b>Warning!</b> Power is passed through this port. This docking connection is certified to UL 1950 for use only with port replicators designed for your Gateway notebook.

## Keyboard area

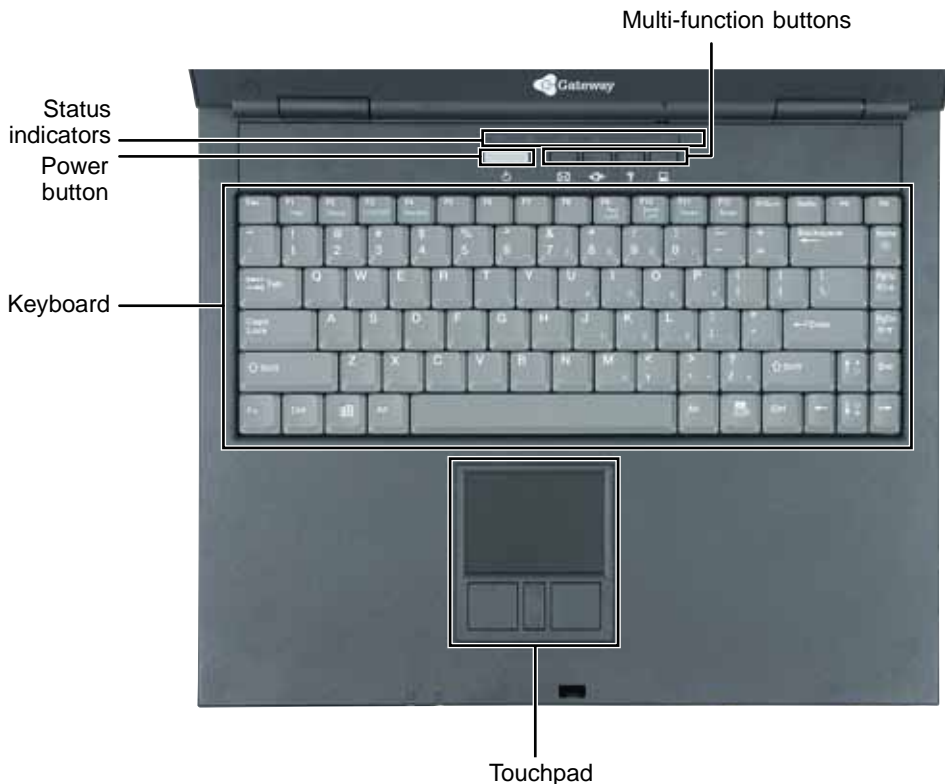
For information on using your keyboard, see [“Using the keyboard” on page 32.](#)



Component	Icon	Description
Multi-function buttons		Press these buttons to open programs assigned to them. These buttons are set to open your default e-mail program, your default Web browser, online help, and the <i>My Computer</i> window. For more information, see <a href="#">“Multi-function buttons” on page 36</a> .
Touchpad		Provides all the functionality of a mouse. For more information, see <a href="#">“Using the EZ Pad touchpad” on page 37</a> .
Keyboard		Provides all the features of a full-sized, 86-key keyboard. For more information, see <a href="#">“Using the keyboard” on page 32</a> .
Power button		Press to turn the power on or off. You can also configure the power button for Standby/Resume mode. For more information, see <a href="#">“Starting your notebook” on page 27</a> .
Status indicators		Inform you when a drive is in use or when a button has been pressed that affects how the keyboard is used. For more information, see <a href="#">“Status indicators” on page 30</a> .

# Identifying your model

**Important**



The labels shown in this section are for informational purposes only. Label information varies by model, features ordered, and location.

## Gateway model and serial number

The label on the bottom of your notebook contains information that identifies your notebook model and its features. Gateway Technical Support will need this information if you call for assistance.

Gateway model number

**Gateway**

FOR USE WITH LSE0208A1965 or FSP065-AAB  
POUR UTILISER AVEC MODEL LSE0208A1965 ou FSP065-AAB  
INPUT:19V =3.42A

MODEL No.: M 405

This class B digital apparatus meets all requirements of the Canadian interference- Causing Equipment Regulations. Cet appareil numérique de la classe B respecte toutes les exigences du Règlement sur le Matériel brouilleur du Canada.

This device complies with Part 15 of the FCC Rules. Operation is subject to the following two conditions:  
(1) this device may not cause harmful interference, and (2) this device must accept any interference received, including interference that may cause undesired operation.

Apparatus Claims of U.S. Patent Nos. 4,631,603; 4,577,216; 4,819,098 and 4,907,093 licensed for limited viewing uses only.

CONFORMS TO ANSUL STD.1950 CERTIFIED TO CAN/CSA STD C22.2 NO.950

ETL US 3022713

**NOM** NVCE

Fitted with internal QCOM TECHNOLOGY INC. modem model number MD560LM Complies with 47 CFR part 68 REN:0.0(B) US:QTM500B MD560LM Complies with Industry Canada CS03 IC: 4654A-MD560LM

FC Tested To Comply With FCC Standards FOR HOME OR OFFICE USE

P/N: [Redacted]

[Redacted]

[Redacted]

TH10 CM

## Gateway serial number

You can locate the Gateway serial number:

- Printed on a white sticker on the bottom or back of your notebook.
- Printed on the customer invoice that came with your notebook. The invoice also contains your customer ID number.



## Internal wireless label

A label similar to the following indicates your notebook contains a wireless communications device. The label is located on the bottom of your notebook.

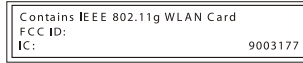

## Microsoft Certificate of Authenticity

The Microsoft Certificate of Authenticity label found on the bottom of your notebook includes the product key code for your operating system.



# Finding your specifications

For more information about your notebook, such as memory size, memory type, and hard drive size, visit Gateway's *eSupport* page at [support.gateway.com](http://support.gateway.com). The *eSupport* page also has links to additional Gateway documentation and detailed specifications. For more information, see “Using eSupport” on page 4.



# Accessories

To order accessories, visit the Accessory Store at [accessories.gateway.com](http://accessories.gateway.com).

## **Batteries and automobile/airplane power adapters**

If you run your notebook on battery power for extended periods, you may want to buy an additional battery so you can swap batteries when necessary. See “[Changing batteries](#)” on page 60 for more information about using an additional battery.

With an automobile/airplane power adapter, you can save battery power by plugging your notebook into an automobile cigarette lighter or an airplane in-flight power receptacle.

## **Carrying cases**

Gateway has large-capacity carrying cases if you need additional space for accessories or supplies.

## **Memory**

Large programs, such as multimedia games or graphics programs, use a lot of memory. If your programs are running more slowly than you think they should, try adding more memory. See “[Adding or replacing memory](#)” on page 67 for more information.

## **Peripheral devices**

You can attach devices (such as a keyboard, mouse, printer, or monitor) to your notebook or optional port replicator.

## **Port replicators**

Although you can attach devices directly to your notebook, a port replicator lets you make all of those connections at one time. When you travel with your notebook, you merely disconnect from the port replicator instead of unplugging all the devices.

A port replicator also provides additional ports and other expansion features not included with your notebook. See “[Using the Optional Port Replicator](#)” on page 75 for more information about using a port replicator with your notebook.

## **Printers**

You can attach almost any type of printer to your notebook. The most common types are inkjet and laser printers, which print in color or black and white.

Inkjet printers and cartridges are relatively inexpensive, but they are slower than laser printers. Using an inkjet color printer, you can print pictures, banners, and greeting cards, as well as documents.

Laser printers and cartridges are more expensive, but they print much faster than inkjet printers. Laser printers are better than inkjet printers when you are printing large documents.

## **USB flash drive**

Use a USB flash drive for storing files or transferring files to another computer.

# Chapter 3

---

## Getting Started



- Connecting the AC adapter
- Turning your notebook on and off
- Using the status indicators, keyboard, and the EZ Pad touchpad
- Adjusting the volume
- Turning wireless networking on and off

# Connecting the AC adapter

You can run your notebook using an AC adapter or your notebook's battery. The battery was shipped to you partially charged. You should use the AC adapter right away to fully charge the battery. Allow three hours for the battery to fully charge.

## Important



If the battery is not fully charged before you use your notebook on battery power for the first time, the battery life may be much shorter than you expect. If the battery life seems short even after being charged for three hours, the battery may need to be recalibrated. For information on recalibrating the battery, see ["Recalibrating the battery"](#) on page 59.

## ▶ To connect the AC adapter:

- 1 Connect the power cord to the AC adapter.



## Caution



Make sure that you use the AC adapter that came with your notebook or one of the same type purchased from Gateway.

Replace the power cord if it becomes damaged. The replacement cord must be of the same type and voltage rating as the original cord or your notebook may be damaged.

- 2 Connect the AC adapter to your notebook's power connector.



- 3 Plug the power cord into a wall outlet.

The battery charge indicator turns on (see [“Status indicators” on page 30](#) for the location of the battery charge indicator).

- 4 When you finish using your notebook for the first time, turn off your notebook and leave your notebook connected to AC power until the battery charge indicator turns green.

**Warning**



Do not attempt to disassemble the AC adapter. The AC adapter has no user-replaceable or user-serviceable parts inside. The AC adapter has dangerous voltages that can cause serious injury or death. Contact Gateway about returning defective AC adapters.

**Important**



If the battery charge indicator does not turn green after three hours, contact Gateway Customer Care at [support.gateway.com](http://support.gateway.com).



## Protecting from power source problems

During a power surge, the voltage level of electricity coming into your notebook can increase to far above normal levels and cause data loss or system damage. Protect your notebook and peripheral devices by connecting them to a *surge protector*, which absorbs voltage surges and prevents them from reaching your notebook.

### Warning



High voltages can enter your notebook through both the power cord and the modem connection. To protect your notebook and avoid electrical shock, use a surge protector. If you have a telephone modem, use a surge protector that has a modem jack. If you have a cable modem, use a surge protector that has an antenna/cable TV jack. During an electrical storm, unplug both the surge protector and the modem.



# Starting your notebook

## ▶ To start your notebook:

- 1 Press the latch on the front of your notebook, then lift the LCD panel.
- 2 Press the power button located above the keyboard.



The power button is preset to On/Off mode. However, you can also set it to function in Standby/Resume mode.

### Tips & Tricks



For more information about changing the power button mode, see "Changing Power-saving Settings" in *Using Your Computer* which has been included on your hard drive. To access this guide, click **Start, All Programs**, then click **Gateway Documentation**.

- 3 If you are starting your notebook for the first time, follow the on-screen instructions to set up your notebook.



## Waking up your notebook

When you have not used your notebook for several minutes or if you close the LCD panel without turning off your notebook, it may enter a power-saving mode called *Standby*. While in Standby, the power indicator flashes.

If your notebook is in Standby mode, press the power button to “wake” it up.

### Tips & Tricks



For more information about changing the power button mode, see “Changing Power-saving Settings” in *Using Your Computer* which has been included on your hard drive. To access this guide, click **Start, All Programs**, then click **Gateway Documentation**.

## Turning off your notebook

### To turn off your notebook:

- 1 Click **Start**, then click **Turn Off Computer**. The *Turn Off Computer* dialog box opens.
- 2 Click **Turn Off**. Windows shuts down and turns off your notebook.

### Important



If for some reason you cannot use the Turn Off Computer option in Windows to turn off your notebook, press and hold the power button for about five seconds, then release it.



# Restarting (rebooting) your notebook

If your notebook does not respond to keyboard or touchpad input, you may have to close programs that are not responding. If closing unresponsive programs does not restore your notebook to normal operation, you may have to restart (reboot) your notebook.



## To close unresponsive programs and restart your notebook:

- 1 Press **CTRL+ALT+DEL**. The *Windows Security* dialog box opens.
- 2 Click **Task Manager**. The *Windows Task Manager* dialog box opens.
- 3 Click the program that is not responding.
- 4 Click **End Task**.
- 5 Click **X** in the top-right corner of the *Windows Task Manager* dialog box.
- 6 If your notebook does not respond, turn it off, wait ten seconds, then turn it on again.

### Important



If your notebook does not turn off immediately, complete the following steps until your notebook turns off:

- 1 Press and hold the power button for about five seconds, then release it.
- 2 Insert a straightened paper clip into the reset hole on the bottom of your notebook.
- 3 Unplug the power cord and remove the battery for more than 10 seconds.





As a part of the regular startup process, a program to check the disk status runs automatically. When the checks are finished, Windows starts.



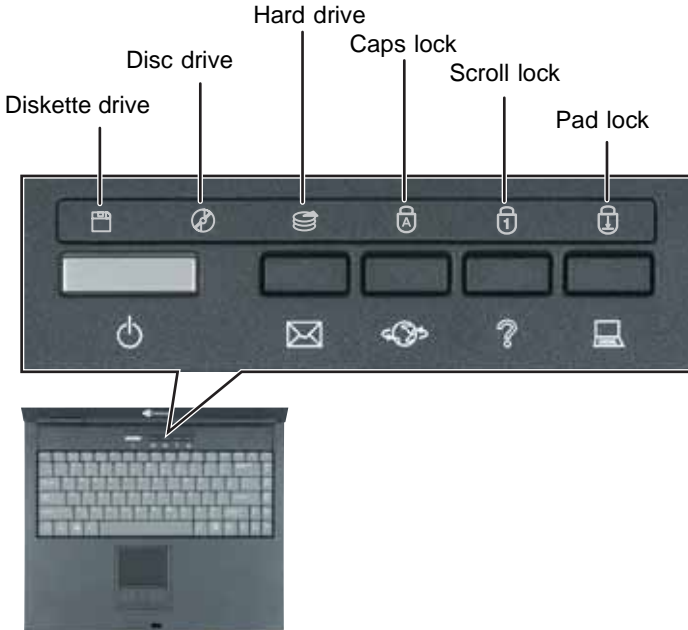

# Status indicators

Status indicators inform you when a drive is being used or when a button has been pressed that affects how the keyboard is used.



Indicator	Icon	Description
Diskette drive		The diskette drive or the memory card reader is in use.
Disc drive		The CD or DVD drive is in use.
Hard drive		The hard drive is in use.
Caps Lock		Caps Lock is turned on.

---

Indicator	Icon	Description
Scroll Lock		Scroll Lock is turned on. For more information, see <a href="#">“System key combinations” on page 34.</a>
Pad Lock		Numeric keypad is turned on. For more information, see <a href="#">“System key combinations” on page 34.</a>

---

# Using the keyboard

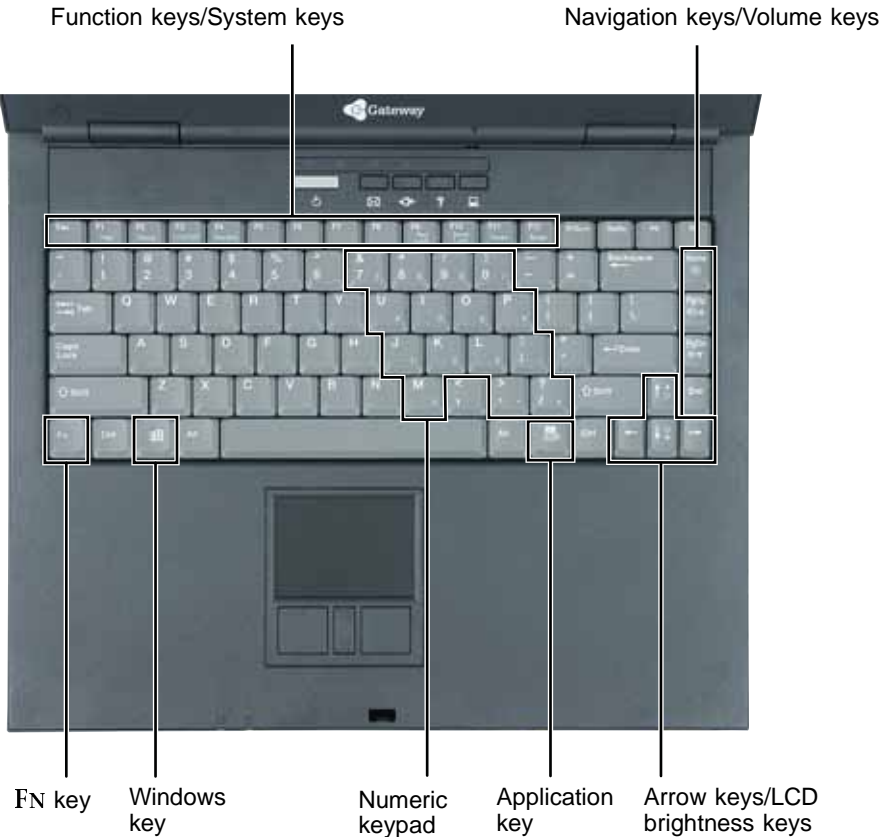

Your notebook features a full-size keyboard that functions the same as a desktop computer keyboard. Many of the keys have been assigned alternate functions, including shortcut keys for Windows, function keys for specific system operations, and the Num Lock keys for the numeric keypad.

You can attach an external keyboard to the notebook using a USB port. You do not need to shut down the notebook to connect a USB keyboard. You can also attach an external keyboard to your optional port replicator using a USB or PS/2 port.











# Key types

The keyboard has several different types of keys. Some keys perform specific actions when pressed alone and other actions when pressed in combination with another key.

Key type	Icon	Description
Function keys		Press these keys labeled <b>F1</b> to <b>F12</b> to perform actions in programs. For example, pressing <b>F1</b> may open help. Each program uses different function keys for different purposes. See the program documentation to find out more about the function key actions.
System keys		Press these colored keys in combination with the <b>FN</b> key to perform specific actions. For more information, see <a href="#">“System key combinations” on page 34</a> .
Navigation keys		Press these keys to move the cursor to the beginning of a line, to the end of a line, up the page, down the page, to the beginning of a document, or to the end of a document.
Volume keys		Press these colored keys in combination with the <b>FN</b> key to increase or decrease the volume or to turn off all sound.
FN key		Press the <b>FN</b> key in combination with a colored system key (such as <b>STATUS</b> , <b>STANDBY</b> , or <b>PAUSE</b> ) to perform a specific action.
Windows key		Press this key to open the Windows <b>Start</b> menu. This key can also be used in combination with other keys to open utilities like <b>F</b> (Search utility), <b>R</b> (Run utility), and <b>E</b> (Explorer utility).
Application key		Press this key for quick access to shortcut menus and help assistants in Windows.
Arrow keys		Press these keys to move the cursor up, down, right, or left.
LCD brightness keys		Press these colored keys in combination with the <b>FN</b> key to control the screen brightness.

## System key combinations

When you press the FN key and a system key at the same time, your notebook performs the action identified by the colored text or icon on the key.

Press and hold FN, then press this system key...	To...
	Display the power status box in the upper-left corner of your display. The box shows the battery charge level, the BIOS version, and whether the AC adapter is being used. Press the key combination again to close this box.
	Toggle your notebook's display between the LCD, an external monitor, or both displays at the same time. A monitor must be plugged into the monitor port on your notebook.
	Enter Standby mode. Press the power button to leave Standby mode. For more information, see <a href="#">"Changing power modes" on page 63</a> .
	Turn on Pad Lock so you can use the numeric keypad. Press this key combination again to turn off Pad Lock. The Pad Lock status indicator appears when this function is turned on.
	Pause the text scrolling in a DOS screen. Press this key combination again to continue scrolling. The Scroll Lock status indicator appears when this function is turned on. (This function is only available in some programs.)
	Pause execution of a DOS program. (This function is only available in some programs.)
	Stop the currently running DOS program. (This function is only available in some programs.)
	Increase the brightness of the display.



---

Press and hold FN, then  
press this system key...

To...



Decrease the brightness of the display.



Mute the sound. Press the key combination again to restore the sound. For more information, see [“Adjusting the volume” on page 40](#).



Increase volume. For more information, see [“Adjusting the volume” on page 40](#).







Decrease volume. For more information, see [“Adjusting the volume” on page 40](#).

---

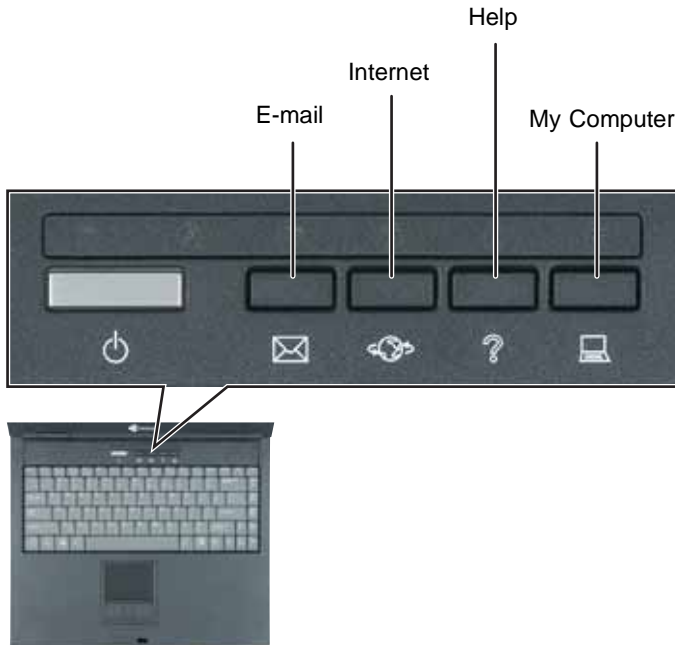
# Multi-function buttons

Press the multi-function buttons to open the programs associated with them.



Button	Icon	Press to...
E-mail		Open your default e-mail program.
Internet		Open your default Web browser.
Help		Open online help.
My Computer		Open the <i>My Computer</i> window.

# Using the EZ Pad touchpad

The EZ Pad™ consists of a touchpad, two buttons, and a rocker switch.

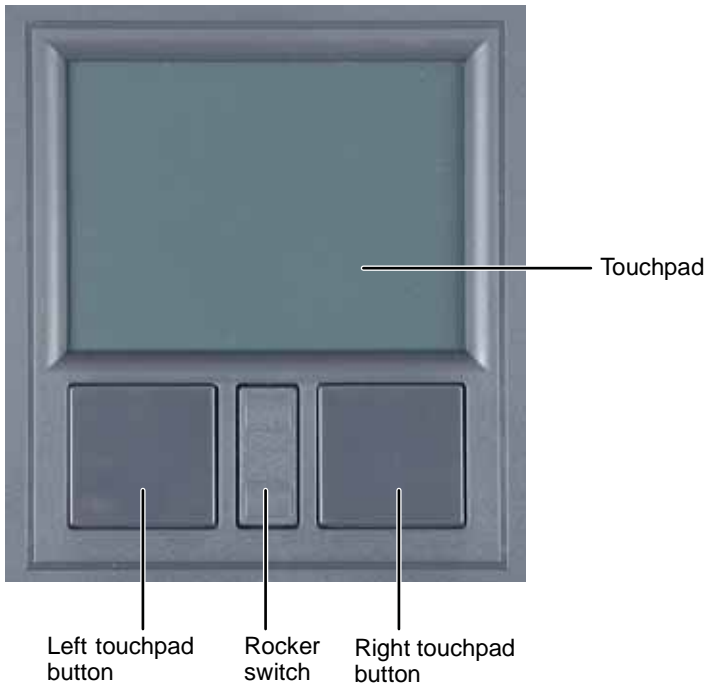

When you move your finger on the touchpad, the *pointer* (arrow) on the screen moves in the same direction.

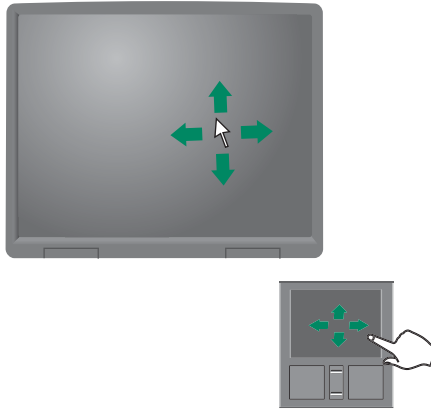

You can use the EZ-Pad *left* and *right buttons* below the touchpad to select objects.

You can assign a function to the *rocker switch* between the touchpad buttons. This function can be to scroll up or down, maximize or minimize the active window, or open and close the Start menu.

#### Tips & Tricks



For instructions on how to adjust the double-click speed, pointer speed, right-hand or left-hand configuration, and other touchpad settings, see “Changing the mouse or touchpad settings” in *Using Your Computer* which has been included on your hard drive. To access this guide, click **Start, All Programs**, then click **Gateway Documentation**.

# Using the touchpad

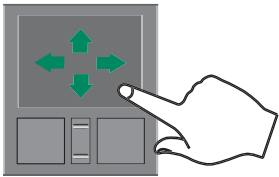
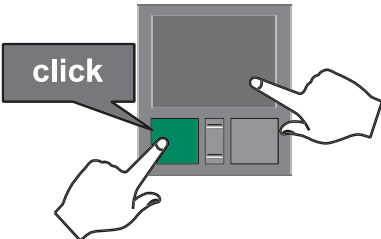
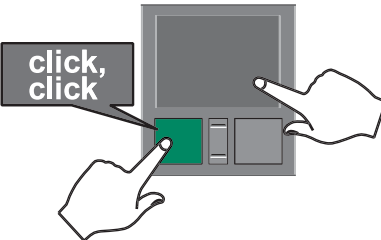
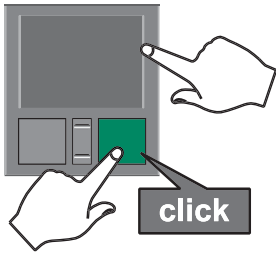
To...	Do this...	
Move the pointer on the screen.		Move your finger around on the touchpad. If you run out of space and need to move the pointer farther, lift your finger, move it to the middle of the touchpad, then continue moving your finger.
Select an object on the screen.		Position the pointer over the object. Quickly press and release the left button once. This action is called <i>clicking</i> .
Start a program or open a file or folder.		Position the pointer over the object. Press the left button twice in rapid succession. This action is called <i>double-clicking</i> .
Access a shortcut menu or find more information about an object on the screen.		Position the pointer over the object. Quickly press and release the right button once. This action is called <i>right-clicking</i> .

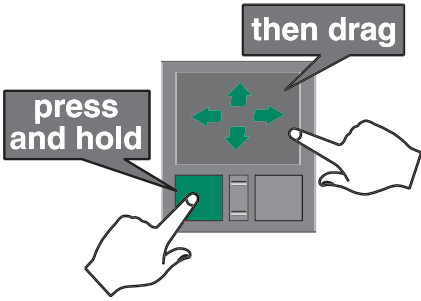
To...	Do this...
Move an object on the screen.	 <p>Position the pointer over the object. Press the left button and hold it down, then use the touchpad to move (drag) the object to the appropriate part of the screen. Release the button to drop the object where you want it.</p>

## Adjusting the volume

You can use the volume control to adjust the overall volume your notebook.

### To adjust the overall volume level using hardware controls:

- If you are using external speakers, turn the knob on the front of the speakers.

-OR-

Use the mute and volume control buttons on the keyboard. For more information, see [“System key combinations” on page 34.](#)



#### Tips & Tricks



For instructions on how to adjust the volume in Windows, see “Adjusting the Volume” in *Using Your Computer* which has been included on your hard drive. To access this guide, click **Start, All Programs**, then click **Gateway Documentation**.

# Turning your wireless network on or off

## Warning



Radio frequency wireless communication can interfere with equipment on commercial aircraft. Current aviation regulations require wireless devices to be turned off while traveling in an airplane. IEEE 802.11a, IEEE 802.11b, and IEEE 802.11g communication devices are examples of devices that provide wireless communication.

## Warning



In environments where the risk of interference to other devices or services is harmful or perceived as harmful, the option to use a wireless device may be restricted or eliminated. Airports, Hospitals, and Oxygen or flammable gas laden atmospheres are limited examples where use of wireless devices may be restricted or eliminated. When in environments where you are uncertain of the sanction to use wireless devices, ask the applicable authority for authorization prior to use or turning on the wireless device.



## To turn wireless networking on or off:

- 1 Click **Start**, then click **Control Panel**. The *Control Panel* window opens. If your Control Panel is in Category View, click **Network and Internet Connections**. The *Network and Internet Connections* window opens.
- 2 Click/Double-click **Network Connections**. The *Network Connections* window opens.
- 3 Right-click **Wireless Network Connection**, then click **Enable** to turn on wireless networking or click **Disable** to turn off wireless networking.







# Chapter 4

---

## Using Drives and Ports





- Using DVD drives
- Using the diskette drive
- Using the media card reader
- Using a PC Card
- Viewing the display on a monitor or projector

# Using the CD or DVD drive

You can use your notebook to enjoy a wide variety of multimedia features.

## Identifying drive types

Your Gateway notebook may contain one of the following drive types. Look on the front of the drive for one or more of the following logos:

If your drive has this logo...	This is your drive type...	Use your drive for...
	CD drive	Installing programs, playing audio CDs, and accessing data. You cannot use this drive to create CDs or DVDs or play DVDs.
	DVD drive	Installing programs, playing audio CDs, playing DVDs, and accessing data. You cannot use this drive to create CDs or DVDs.
	Combination DVD/CD-RW drive	Installing programs, playing audio CDs, playing DVDs, accessing data, and recording music and data to CD-R or CD-RW discs. You cannot use this drive to create DVDs.
	Recordable DVD Drive	Installing programs, playing audio CDs, playing DVDs, accessing data, recording music and data to recordable CDs, and recording video and data to recordable DVDs.

### Tips & Tricks



For more information, see [“Creating CDs and DVDs” on page 46](#).

## Inserting a CD or DVD



### Important



Some music CDs have copy protection software. You may not be able to play these CDs on your notebook.

### To insert a CD or DVD:

- 1 Press the eject button on the DVD drive. After the tray opens slightly, pull the disc tray completely open.
- 2 Place the disc in the tray with the label facing up, then press down carefully on the disc until it snaps into place.

### Important



When you place a single-sided disc in the tray, make sure that the label side is facing up. If the disc has two playable sides, place the disc so the name of the side you want to play is facing up.

- 3 Push the tray in until it is closed.



## Playing a CD

Use the music program or Windows Media Player on your notebook to:

- Play music CDs
- Create MP3 music files from your music CDs
- Edit music track information
- Use your music files to build a music library
- Listen to Internet Radio

### Tips & Tricks



For more information about playing CDs, see “Playing CDs” in *Using Your Computer* which has been included on your hard drive. To access this guide, click **Start, All Programs**, then click **Gateway Documentation**.

## Playing a DVD

A Digital Versatile Disc (DVD) is similar to a CD but has greater data capacity. Because of this increased capacity, full-length movies, several albums of music, or several gigabytes of data can fit on a single disc. You can play DVDs with the DVD program or Windows Media Player.

### Tips & Tricks



For more information about playing DVDs, see “Playing DVDs” in *Using Your Computer* which has been included on your hard drive. To access this guide, click **Start, All Programs**, then click **Gateway Documentation**.

## Creating CDs and DVDs

You can use the CD and DVD burning program on your notebook to copy tracks from a music CD to your hard drive, copy or create data CDs and DVDs, create music CDs, create video DVDs, and more.

### Tips & Tricks



For more information about creating CDs and DVDs, see “Creating CDs and DVDs” in *Using Your Computer* which has been included on your hard drive. To access this guide, click **Start, All Programs**, then click **Gateway Documentation**.

# Using the optional diskette drive

The diskette drive uses 3.5-inch diskettes (sometimes called *floppy disks*). Diskettes are useful for storing files or transferring files to another computer.

## Warning



Do not expose diskettes to water or magnetic fields. Exposure could damage the data on the diskette.

## Tips & Tricks



Your notebook comes with either a built-in diskette drive or a built-in memory card reader. If your notebook has a built-in memory card reader and you need to use a diskette drive, we recommend purchasing a USB diskette drive. To order a USB diskette drive, visit the Accessory Store at [accessories.gateway.com](http://accessories.gateway.com).



## To use a diskette:

- 1 Insert the diskette into the diskette drive with the label facing up.
- 2 To access a file on the diskette, click **Start**, then click **My Computer**. Double-click the drive letter (for example, the A: drive), then double-click the file name.
- 3 To remove the diskette, make sure that the diskette drive status indicator (see “[Status indicators](#)” on page 30) is off, then press the diskette eject button.



# Using the optional memory card reader

## Tips & Tricks



Your notebook comes with either a built-in diskette drive or a built-in memory card reader. If your notebook has a built-in diskette drive and you need to use a memory card reader, we recommend purchasing a USB memory card reader. To order a USB memory card reader, visit the Accessory Store at [accessories.gateway.com](http://accessories.gateway.com).

You can use memory cards to transfer pictures from a digital camera to your notebook. You can also use the memory card reader to transfer data between your notebook and a device that uses memory cards, such as a PDA, MP3 player, or cellular telephone.

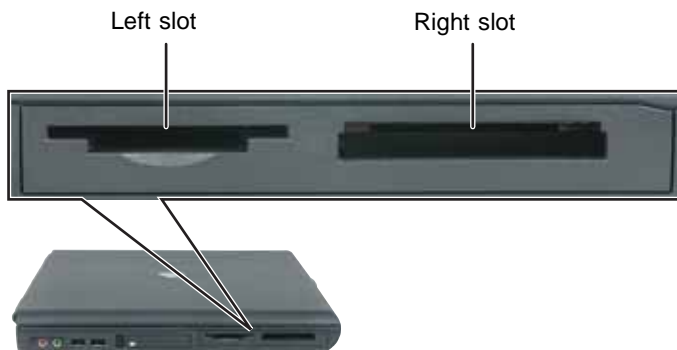

## Memory card types

The memory card reader supports the following card types.

Card Type	Slot	Card Type	Slot
CompactFlash <sup>®</sup>	right	MultiMediaCard <sup>™</sup>	left
IBM Microdrive <sup>™</sup>	right	Secure Digital <sup>™</sup>	left
Memory Stick <sup>®</sup>	left	SmartMedia <sup>™</sup> (3.3V only)	left

Each slot is assigned a different drive letter (for example, the E: and F: drives) so data can be transferred from one card type to another.

# Using a memory card

## To insert a memory card:

- 1 Insert the memory card into the memory card slot with the label facing up and the arrow on the label pointing towards your notebook.

### Important



Insert the SmartMedia card with the label facing down. Your notebook only accepts 3.3V SmartMedia cards.



- 2 To access a file on the memory card, click **Start**, then click **My Computer**. Double-click the drive letter (for example, the E: drive), then double-click the file name.



## To remove a memory card:

- Make sure that the diskette drive status indicator (see “[Status indicators](#)” on page 30) is off, then pull the memory card out of the notebook.



### Important



Do not use the remove hardware  icon in the taskbar to remove the memory card.

## Adding and removing a PC Card

Your notebook has a PC Card slot (also known as a PCMCIA card slot). This slot accepts one Type II or Type III card.

You do not need to restart your notebook when changing most cards because your notebook supports *hot-swapping*. Hot-swapping means that you can insert a PC Card while your notebook is running. If your PC Card does not work after hot-swapping, see the PC Card manufacturer’s documentation for further information.



 **To insert a PC Card:**

- Push the card firmly into the PC Card slot label-side up until the outer edge of the card is flush with the side of your notebook.



 **To remove a PC Card:**

- 1 Click the remove hardware  icon in the taskbar, the PC Card name, then click **Stop**.

-OR-

Turn off your notebook.

**Important**



If the remove hardware icon does not appear on the taskbar, click the show hidden icons  button.

- 2 Release the eject button by pressing the PC Card eject button once.
- 3 Eject the PC Card by pressing the eject button again.



# Viewing the display on a projector or monitor

You can use your notebook for giving presentations by connecting an external monitor or projector to your monitor (VGA) port. Your notebook supports simultaneous LCD and CRT display. Simultaneous display lets you control the presentation from your notebook and at the same time face your audience.



## To use a projector or external monitor:

- 1 Turn off your notebook.
- 2 Plug the projector or monitor cable into the VGA port on your notebook or optional port replicator. For the location of the VGA port, see [“Back” on page 14](#) or [“Back” on page 78](#).
- 3 Turn on your notebook.
- 4 Plug the projector’s or monitor’s power cord into an AC power source and turn it on. Windows recognizes the new hardware and searches for its driver. You may need to install the driver from the disc supplied by the manufacturer or download the driver from the manufacturer’s Web site.
- 5 After the driver is installed, right-click any empty space on the desktop, then click **Properties**. The *Display Properties* dialog box opens.

- 6 Click the **Settings** tab.

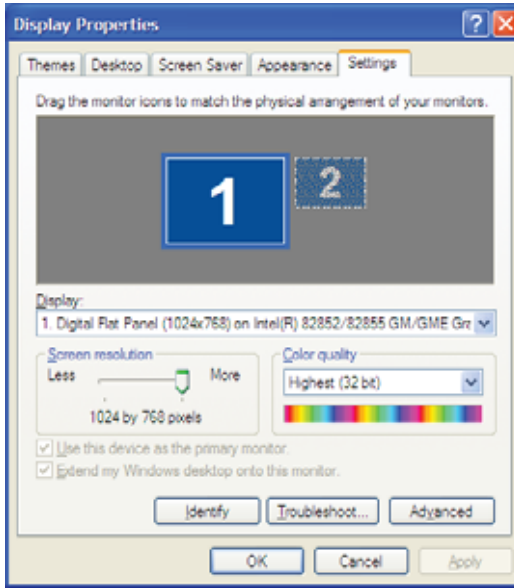

- 7 Right-click the second monitor icon (labeled 2), then click **Attached**.
- 8 Click **Apply**.
- 9 Adjust properties such as **Screen Resolution** or **Color Quality** if necessary.
- 10 Click **OK**.



**Important**



Press FN+F3 to switch between viewing the display on the LCD panel and viewing the display on the projector or monitor.

**Important**



If an external monitor or projector is connected and you close the LCD panel, your notebook may turn off the LCD panel, but will not enter Standby mode.

# Chapter 5

---

## Managing Power





- Checking and recharging the battery
- Recalibrating the battery
- Changing batteries
- Extending the life of the battery

# Monitoring the battery charge

Your new Gateway notebook is designed to provide an exceptional balance of performance and portability. Your notebook uses the latest chipset and mobile processor technologies to manage the processor speed and power consumption for a greater battery life experience. This design provides you with maximum performance when plugged into AC power balanced with optimized battery life when on battery power.

Closely monitor the battery charge. When the battery charge gets low, change the battery or connect to AC power immediately to prevent losing any unsaved work.

To monitor the battery charge:

- Double-click the power cord icon  or battery icon  in the taskbar. The *Power Meter* dialog box opens.

## Important



If the power cord or battery icon does not appear on the taskbar, click the show hidden icons  button. If the icon still does not appear, make sure that **Always show icon on the taskbar** is checked on the Power Options Properties Advance tab.

For more information, see “Changing advanced settings” in *Using Your Computer* which has been included on your hard drive. To access this guide, click **Start**, **All Programs**, then click **Gateway Documentation**.

- Pressing FN+STATUS to view the power status box, which opens in the upper-left corner of the screen. The power status box shows the current power source, the battery charge level, and the power management mode.
- Looking at the battery charge indicator:
  - LED green - battery is fully charged.
  - LED orange - battery is charging.
  - LED blinking red - battery charge is very low.
  - LED solid red - battery is malfunctioning.

**Important**



This LED only lights up when the notebook is connected to AC power. For the location of the battery charge indicator, see [“Status indicators” on page 30](#).

- Pressing the battery meter buttons on the battery. The battery meter lights indicate the percentage of battery charge remaining.



- Wait for a Low Battery warning message to appear.

If your battery charge indicator displays what looks like an inaccurate charge, you may need to recalibrate the battery. For more information, see [“Recalibrating the battery” on page 59](#).

# Recharging the battery

The battery recharges while it is installed and your notebook is connected to AC power. While the battery is recharging, the battery charge indicator turns on and the battery icon in the taskbar has a lightning bolt .

## Important



If the power cord or battery icon does not appear on the taskbar, click the show hidden icons  button. If the icon still does not appear, make sure that **Always show icon on the taskbar** is checked on the Power Options Properties Advance tab.

For more information, see “Changing advanced settings” in *Using Your Computer* which has been included on your hard drive. To access this guide, click **Start**, **All Programs**, then click **Gateway Documentation**.



# Recalibrating the battery

If your notebook unexpectedly goes into Standby mode while you are using it but the battery charge is not low, you may need to recalibrate your battery. You should also recalibrate the battery periodically to maintain the accuracy of the battery gauge.

## To recalibrate the battery:

- 1 Connect the AC adapter, then turn on your notebook.
- 2 As soon as it starts and you see a startup screen, press **F2**. The BIOS Setup utility opens.
- 3 Open the **Advanced** menu.
- 4 Highlight **Battery Auto Learning**, then select **Enabled** by pressing the spacebar.
- 5 Open the **Exit** menu, then highlight **Exit Saving Changes** and press **ENTER**.
- 6 Select **Yes**, then press **ENTER**.

The battery recalibration process begins and a screen opens showing you the progress. The entire process will take several hours.

### Important



Do not interrupt the battery recalibration process. If recalibration is interrupted, you must start the process over again.

When the recalibration has finished, the message “Press [Esc] key to exit” appears.

- 7 Press **Esc**. The battery charge indicator now displays an accurate battery charge. If the battery charge indicator does not show an accurate charge, contact Gateway Technical Support.



# Changing batteries

If your notebook is connected to AC power, you can change the battery while the notebook is turned on.

## Warning



Danger of explosion if battery is incorrectly replaced.

Replace only with a battery specifically manufactured for your Gateway notebook. Discard used batteries according to the manufacturer's instructions.

The battery used in this device may present a fire or chemical burn hazard if mishandled. Do not disassemble, heat above 212°F (100°C), or incinerate. Dispose of used battery promptly. Keep away from children.

## Replacing the battery



### To replace the battery:

- 1 If your notebook is on and is connected to AC power, go to [Step 2](#).

-OR-

If your notebook is on and is not connected to AC power, save your work and turn off your notebook.

- 2 Close the LCD panel.
- 3 Disconnect your notebook from the optional port replicator (see [“Disconnecting from the port replicator” on page 81](#)).
- 4 Turn your notebook over so the bottom is facing up.

- 5 Slide the battery release latch.

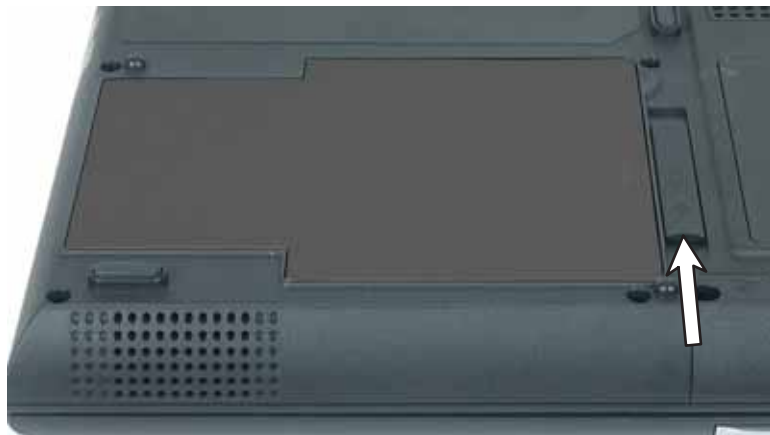

- 6 Lift the battery out of the bay.



- 7 Place a recharged battery into the bay and press down until it snaps into place.
- 8 Turn your notebook over and reattach the optional port replicator.
- 9 Open the LCD panel and press the power button.



# Extending battery life

## Conserving battery power

To conserve power while using the battery to power your notebook:

- Dim the display as low as is comfortable.
- Remove PC Cards and IBM Microdrive cards when you do not need them. Many PC Cards and Microdrive cards use a small amount of power while inserted, even if they are not being used.
- Modify the power management settings for maximum power savings.

### Tips & Tricks



For more information about using power management settings, see “Changing Power-saving Settings” in *Using Your Computer* which has been included on your hard drive. To access this guide, click **Start, All Programs**, then click **Gateway Documentation**.

- Close the LCD panel to turn off the display while you are not using your notebook. The display stays off until you open the panel again.
- Use Hibernate mode for maximum power savings while your notebook is not in use.

### Tips & Tricks



For more information about using Hibernate mode, see “Activating and using Hibernate mode” in *Using Your Computer* which has been included on your hard drive. To access this guide, click **Start, All Programs**, then click **Gateway Documentation**.

- Using the CD, DVD, or recordable drive only when necessary. These drives use a large amount of power.
- Recharge the battery often, take an extra battery, and fully recharge the batteries before traveling. For more information, see [“Recharging the battery” on page 58](#) and [“Changing batteries” on page 60](#).

## Using alternate power sources

To extend battery life, use alternate power sources whenever possible.

- If traveling internationally, take electrical adapters. Save the battery for times when you cannot use a power adapter. If you plan on taking your AC power adapter, also take a single-plug surge protector.
- If you will have access to an EmPower™ in-flight power receptacle or an automobile cigarette lighter, use a power inverter. Save the battery for times when you cannot use a power adapter.
- To find AC power outlets in airports, look for them next to support pillars, in large areas such as boarding gates, and under banks of telephones.

## Changing power modes

You can use the following power modes to lengthen the life of your notebook's battery:

- *Standby* - while your notebook is in Standby, it switches to a low power state where devices, such as the display and drives, turn off.
- *Hibernate* - (also called *save to disk*) writes all current memory (RAM) information to the hard drive, then turns your notebook completely off. The next time you turn on your notebook, it reads the memory information from the hard drive and opens the programs and documents that were open when you activated Hibernate mode.

## Using power saving modes

Always save your work before using Standby mode. In Standby mode, your notebook reduces or turns off the power to most devices except memory. However, the information in memory is not saved to the hard drive. If power is interrupted, the information is lost.

When in Hibernate mode, your notebook saves all memory information to the hard drive, then turns the power completely off.

If your notebook is...	...and you want to...	...then
On	Enter Standby mode	Press <b>FN+STANDBY</b> .
On	Enter Hibernate mode (must be activated)	Click <b>Start</b> , then click <b>Turn Off Computer</b> . Press and hold <b>SHIFT</b> , then click <b>Hibernate</b> .
In Standby or Hibernate mode	Exit Standby or Hibernate mode	Press the power button.

# Chapter 6

---

## Upgrading Your Notebook



- Adding and replacing memory
- Replacing the hard drive

# Preventing static electricity discharge

## Important



Before installing memory or replacing the hard drive, you should read and understand the information in this section.

The components inside your notebook are extremely sensitive to static electricity, also known as *electrostatic discharge* (ESD).

## Warning



To avoid exposure to dangerous electrical voltages and moving parts, turn off your notebook and unplug the power cord, modem cable, and network cable before opening the case.

## Warning



To prevent risk of electric shock, do not insert any object into the vent holes of the notebook.

Before installing memory or replacing the hard drive, follow these guidelines:

- Avoid static-causing surfaces such as carpeted floors, plastic, and packing foam.
- Remove components from their antistatic bags only when you are ready to use them. Do not lay components on the outside of antistatic bags because only the inside of the bags provide electrostatic protection.
- Always hold components by their edges. Avoid touching the edge connectors. Never slide components over any surface.
- Wear a grounding wrist strap (available at most electronics stores) and attach it to a bare metal part of your workbench or other grounded connection.
- Touch a bare metal surface on your workbench or other grounded object.



# Adding or replacing memory

Your notebook uses memory modules called SO-DIMMs (Small Outline Dual Inline Memory Modules). The modules are available in various capacities and any module can be placed in any available slot. Use only memory modules designed for your Gateway notebook for upgrading your memory.



## To add or replace memory modules:

- 1 Follow the guidelines under “Preventing static electricity discharge” on page 66.
- 2 Turn off your notebook.
- 3 Disconnect the AC adapter, modem cable, and network cable.
- 4 Disconnect all peripheral devices and remove any PC cards.
- 5 Disconnect your notebook from the optional port replicator (see “Disconnecting from the port replicator” on page 81).
- 6 Turn your notebook over so the bottom is facing up.

- 7 Remove the battery. For more information, see [“Changing batteries”](#) on page 60.
- 8 Loosen the memory bay cover screw, then remove the memory bay cover.
- 9 If you are removing a module, gently press outward on the clip at each end of the memory module until the module tilts upward.



- 10 Pull the memory module out of the slot.

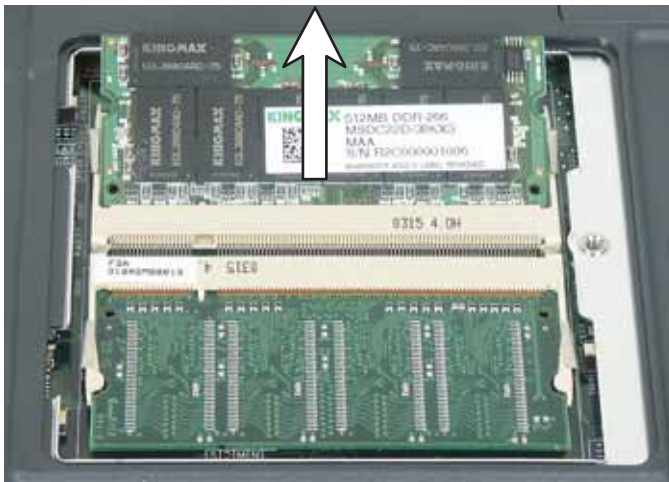

- 11 Hold the new or replacement module at a 30-degree angle and press it into the empty memory slot. This module is keyed so it can only be inserted in one direction. If the module does not fit, make sure that the notch in the module lines up with the tab in the memory bay.

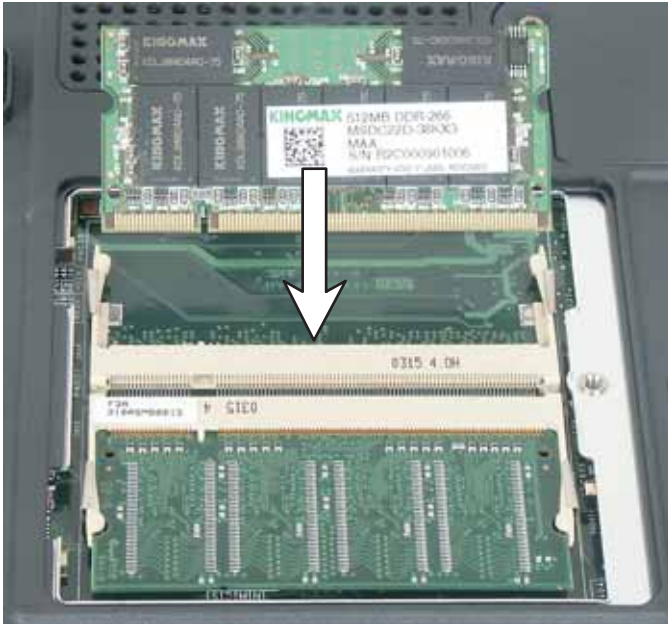

**Important**



Use only memory modules designed for the Gateway M405.

- 12 Gently push the module down until it clicks in place.
- 13 Replace the memory bay cover and tighten the cover screw.
- 14 Insert the battery, then turn your notebook over.
- 15 Reattach the optional port replicator.
- 16 Connect the power adapter, modem cable, and network cable, then turn on your notebook.



# Replacing the hard drive kit

If you would like more hard drive capacity, you can replace your original drive with a higher-capacity drive.



Hard drive

## To replace the hard drive kit:

- 1 Back up any data you want to transfer to the new hard drive. For more information, see “Backing up files” in *Using Your Computer* which has been included on your hard drive. To access this guide, click **Start**, **All Programs**, then click **Gateway Documentation**.
- 2 Follow the guidelines under “Preventing static electricity discharge” on page 66.
- 3 Turn off your notebook.
- 4 Disconnect the AC adapter, modem cable, and network cable.
- 5 Disconnect all peripheral devices and remove any PC cards.

- 6 Disconnect your notebook from the optional port replicator (see “Disconnecting from the port replicator” on page 81).
- 7 Turn your notebook over so the bottom is facing up.
- 8 Remove the battery. For more information, see “Changing batteries” on page 60.
- 9 Remove the two hard drive kit screws.



### Tips & Tricks



Use a magnetic screwdriver or turn the notebook over to remove the screws.

- 10** Slide the old hard drive kit out of your notebook.



- 11** If your new hard drive already includes the hard drive kit bracket, go to [Step 16](#).

-OR-

If you need to move the hard drive kit bracket from your old hard drive to your new hard drive, go to [Step 12](#).

- 12 Remove the two screws that secure the hard drive to the hard drive kit bracket.



- 13 Remove the bracket from the old drive.



- 14 Insert the new drive into the bracket so the screw holes line up.
- 15 Replace the two screws that secure the bracket to the drive.
- 16 Place the new hard drive kit into the bay and slide it into the connector.

- 17** Replace the screws that secure the hard drive kit to your notebook.
- 18** Insert the battery, then turn your notebook over.
- 19** Reattach the optional port replicator.
- 20** Connect the power adapter, modem cable, and network cable, then turn on your notebook.
- 21** For instructions on installing Windows, your drivers, and your applications, see the instructions that were included with the restore discs.





# Chapter 7

---

## Using the Optional Port Replicator



- Identifying features
- Connecting and disconnecting the port replicator
- Securing the port replicator with a locking cable

# Front



Component	Icon	Description
Docking release latch		Press both release latches to release the notebook.
Docking port		Connect the notebook to this port. <b>Warning!</b> Power is passed through this port. This docking connection is certified to UL 1950 for use only with notebooks designed for your Gateway port replicator.

# Left









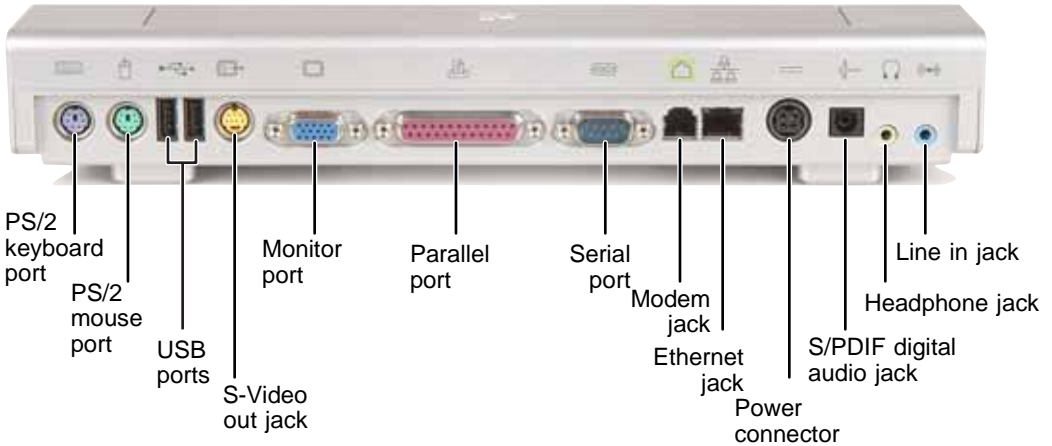





Power  
connector

Component	Icon	Description
Power connector		Plug the AC adapter cable into this connector. <b>Important:</b> The power connector may be located on the back of your port replicator.

# Back



Component	Icon	Description
PS/2 keyboard port		Plug a PS/2 keyboard into this port. Attaching a PS/2 keyboard to your port replicator may deactivate the built-in keyboard.
PS/2 mouse port		Plug a PS/2 mouse into this port. Attaching a PS/2 mouse to your port replicator may deactivate the touchpad.
USB ports		Plug USB (Universal Serial Bus) devices (such as a USB Iomega™ Zip™ drive, printer, scanner, camera, keyboard, or mouse) into these ports.
S-Video out jack		This jack does not work with the Gateway 405 notebook.
Monitor port		Plug an analog VGA monitor or projector into this port. For more information, see <a href="#">“Viewing the display on a projector or monitor” on page 53.</a>
Parallel port		Plug a parallel device (such as a printer) into this port.
Serial port		This jack does not work with the Gateway 405 notebook.

Component	Icon	Description
Modem jack		Plug a modem cable into this jack.
Ethernet jack		Plug a 10/100 Ethernet network cable into this jack.
Power connector		Plug the AC adapter cable into this connector. <b>Important:</b> If your port replicator has a power connector on the left side (see <a href="#">“Left” on page 77</a> ), plug the Gateway 405 AC adapter into that connector. If your port replicator does not have a power connector on the left side, plug the Gateway 405 AC adapter into this connector.
S/PDIF digital audio jack		Plug an optical (Toslink) AC-3 digital audio cable into this jack.
Headphone jack		Plug amplified speakers or headphones into this jack. The built-in speakers on the notebook are turned off when speakers or headphones are plugged into this jack. This jack is turned off when headphones are plugged into the notebook’s headphone jack.
Line in jack		Connect an external audio input source (such as a stereo) to this jack so you can record sound on your notebook or play sound through the notebook speakers.

# Connecting to the port replicator

You can attach your notebook to the port replicator while your notebook is off, on, or in Standby mode.

## Attaching to the port replicator

### ▶ To attach your notebook to the port replicator:

- 1 Connect external devices to the ports on the port replicator.
- 2 Align the connector holes on the bottom of your notebook with the docking posts on the port replicator.
- 3 Press down on the notebook until it snaps into place.



#### Caution



Press down on the outside edges of the notebook. Do not press in the middle or you may damage the LCD screen.

**Important**

The notebook may detect additional devices and add drivers after being attached to the port replicator. This process must be completed for components to work correctly. Follow any on-screen instructions, if necessary.

## Disconnecting from the port replicator

You can separate your notebook from the port replicator while your notebook is off or on (not in Standby or Hibernate mode).

### To separate your notebook from the port replicator:

- 1 If your notebook is off, go to [Step 2](#).

-OR-

If your notebook is on, click **Start**, then click **Undock Computer**. The Undock Computer menu item appears in the Start menu only while the notebook is docked.

- 2 Press down on the docking release latches. The notebook will spring up slightly.



- 3 Lift the notebook off of the port replicator.



# Securing your port replicator

You can secure your notebook and port replicator to an object by using the security ring located on the right side of the port replicator and the Kensington lock slot located on the right side of your notebook.



## To secure your notebook and port replicator:

- 1 Open the security ring on the port replicator.
- 2 Attach your notebook to the port replicator.
- 3 Secure one end of the Kensington cable to a solid object, then run the other end of the cable through the security ring and lock it into the slot provided on the right side of your notebook.





# Chapter 8

---

## Maintaining Your Notebook



- Caring for your notebook
- Cleaning your notebook
- Protecting your notebook from viruses
- Updating Windows
- Restoring your system

# Caring for your notebook

To extend the life of your notebook:

- Be careful not to bump or drop your notebook, and do not put any objects on top of it. The case, although strong, is not made to support extra weight.
- When transporting your notebook, we recommend that you put it in a carrying case.

## Tips & Tricks



For more information about traveling with your notebook, see “Traveling With Your Notebook” in *Using Your Computer* which has been included on your hard drive. To access this guide, click **Start, All Programs**, then click **Gateway Documentation**.

- Keep your notebook away from magnetic fields. Magnetic fields can erase data on hard drives.
- Never turn off your notebook when the hard drive light is on because data on the hard drive could be lost or corrupted.
- Avoid subjecting your notebook to extreme temperature changes. The case (and LCD panel) can become brittle and easy to break in cold temperatures and can melt or warp in high temperatures. Damage due to either extreme is not covered by your warranty. As a general rule, your notebook is safest at temperatures that are comfortable for you.
- Keep all liquids away from your notebook. When spilled onto notebook components, almost any liquid can result in extremely expensive repairs that are not covered under your warranty.
- Avoid dusty or dirty work environments. Dust and dirt can clog the internal mechanisms and can lead to permanent damage to the notebook.
- Do not block the ventilation fan slots. If these slots are blocked, your notebook may overheat resulting in unexpected shutdown or permanent damage to the notebook.
- When storing your notebook for an extended period of time, unplug AC power and remove the battery after discharging it partway.

# Cleaning your notebook

Keeping your notebook clean and the vents free from dust helps keep your notebook performing at its best. You may want to gather these items and put together a notebook cleaning kit:

- A soft, lint-free cloth
- An aerosol can of air that has a narrow, straw-like extension
- Cotton swabs
- A DVD drive cleaning kit

## Cleaning the exterior

### Warning



When you shut down your notebook, the power turns off, but some electrical current still flows through your notebook. To avoid possible injury from electrical shock, unplug the power cord, modem cable, and network cable from the wall outlets.

Always turn off your notebook and other peripherals before cleaning any components. Also, remove the battery before cleaning any components.

Use a damp, lint-free cloth to clean your notebook and other parts of your system. Do not use household abrasive or solvent cleaners because they can damage the finish on components.

Your notebook is cooled by air circulated through the vents on the case, so keep the vents free of dust. With your notebook turned off and unplugged, brush the dust away from the vents with a damp cloth. Be careful not to drip any water into the vents. Do not attempt to clean dust from the inside of your notebook.

## Cleaning the keyboard

You should clean the keyboard occasionally by using an aerosol can of air with a narrow, straw-like extension to remove dust and lint trapped under the keys.

If you spill liquid on the keyboard, turn off your notebook and turn the notebook upside down. Let the liquid drain, then let the keyboard dry before trying to use it again. If the keyboard does not work after it dries, you may need to replace it.

## Cleaning the notebook screen

To clean a notebook LCD screen, use a soft cloth and water to clean the LCD screen. Squirt a little water on the cloth (never directly on the screen), and wipe the screen with the cloth.

**Caution**



A notebook LCD screen is made of specially coated glass and can be scratched or damaged by abrasive or ammonia-based glass cleaners.

## Cleaning CDs or DVDs

Wipe from the center to the edge, not around in a circle, using a product made especially for the purpose.



# Protecting your notebook from viruses

A *virus* is a program that attaches itself to a file on a computer, then spreads from one computer to another. Viruses can damage data or cause your notebook to malfunction. Some viruses go undetected for a period of time because they are activated on a certain date.

Protect your notebook from a virus by:

- Registering your copy of Norton AntiVirus and subscribing to the virus definition update service. You received a free limited time subscription to the Norton AntiVirus service when you purchased your notebook.
- Using the Norton® AntiVirus program to check files and programs that are attached to e-mail messages or downloaded from the Internet.
- Checking all programs for viruses before installing them.
- Disabling macros on suspicious Microsoft Word and Excel files. These programs will warn you if a document that you are opening contains a macro that might have a virus.
- Periodically updating the Norton AntiVirus program to protect against the latest viruses.
- Making sure the Windows Security Center is configured to provide you with the highest level of protection.

## Tips & Tricks



For more information about modifying security settings, see “Modifying Security Settings” in *Using Your Computer* which has been included on your hard drive. To access this guide, click **Start**, **All Programs**, then click **Gateway Documentation**.

## Help and Support



For more information about protecting your notebook against viruses, click **Start**, then click **Help and Support**. Type the keyword **viruses** in the **Search** box

Search  , then click the arrow.

**To scan for viruses:**

- 1 Click **Start, All Programs, Norton AntiVirus**, then click **Norton AntiVirus 2004**. Norton AntiVirus opens.

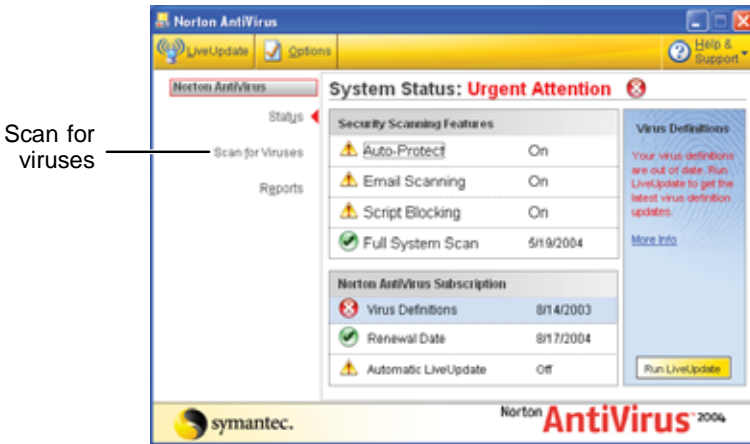

- 2 Click **Scan for Viruses**.

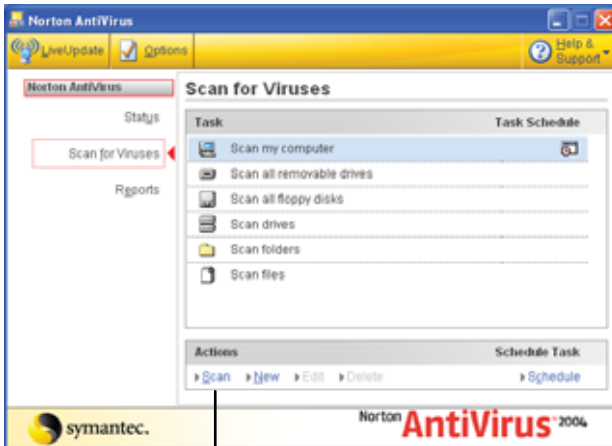

- 3 Click the type of scan you want to make in the Scan for Viruses area, then under Actions, click **Scan**.





### To remove a virus:

- 1 If Norton AntiVirus finds a virus, follow all on-screen instructions to remove the virus.
- 2 Turn off your notebook and leave it off for at least 30 seconds.
- 3 Turn on your notebook and rescan for the virus.



### To update Norton AntiVirus:

#### Important



You received a free limited time subscription to the Norton AntiVirus service when you purchased your notebook. To update Norton AntiVirus after the free subscription period, you must extend your subscription.

- 1 Make sure that you are connected to the Internet.
- 2 Click **Start, All Programs, Norton AntiVirus**, then click **LiveUpdate - Norton AntiVirus**. The LiveUpdate wizard opens.
- 3 Follow the on-screen instructions to update your Norton AntiVirus program with the latest virus protection files.
- 4 When the program has finished, click **Finish**.



# Updating Windows

Windows Update is the online extension of Windows that helps you to keep your notebook up-to-date. Use Windows Update to choose updates for your notebook's operating system, software, and hardware. New content is added to the site regularly, so you can always get the most recent updates and fixes to protect your notebook and keep it running smoothly. Windows Update scans your notebook and provides you with a tailored selection of updates that apply only to the software and hardware on your notebook.

## To run Windows Update:

- 1 Connect to the Internet.
- 2 Click **Start**, **All Programs**, then click **Windows Update**.
- 3 Follow the on-screen instructions.



### Help and Support



For more information about Windows Update in Windows XP, click **Start**, then click **Help and Support**. Type the keyword **Windows Update** in the HelpSpot **Search** box  , then click the arrow.

# Restoring your system

All programs that were preinstalled on your notebook are available on the backup restore discs that you created with the recovery media program, on the hard drive, or on restore discs that were included with your notebook. If you need to restore your notebook to the original configuration, you can use the backup restore discs or you can use the backup files located on the hard drive.

The instructions for using the restore discs or hard drive backup files are included in the instruction booklet that came with your restore discs.



# Chapter 9

---

## Troubleshooting



- Troubleshooting typical hardware and software problems
- Getting telephone support
- Using automated troubleshooting systems

# Safety guidelines

While troubleshooting your notebook, follow these safety guidelines:

- Never remove the memory bay or hard drive bay cover while your notebook is turned on, while the battery is installed, and while the modem cable, network cable, and AC power adapter are connected to your notebook.
- Make sure that you are correctly grounded before accessing internal components. For more information about preventing damage from static electricity, see [“Preventing static electricity discharge” on page 66](#).
- After you complete any maintenance tasks where you remove the memory bay or hard drive bay cover, make sure that you replace the cover, reinstall any screws, then replace the battery before you start your notebook.

## Warning



Do not try to troubleshoot your problem if power cords or plugs are damaged, if your notebook was dropped, or if the case was damaged. Instead, unplug your notebook and contact a qualified computer technician.

# First steps

If you have problems with your notebook, try these things first:

- Make sure that the AC power adapter is connected to your notebook and an AC outlet and that the AC outlet is supplying power.
- If you use a power strip or surge protector, make sure that it is turned on.
- If a peripheral device (such as a keyboard or mouse) does not work, make sure that all connections are secure.
- Make sure that your hard drive is not full.
- If an error message appears on the screen, write down the exact message. The message may help Gateway Customer Care in diagnosing and fixing the problem.
- If you added or removed peripheral devices, review the installation procedures you performed and make sure that you followed each instruction.
- If an error occurs in a program, see the program's printed documentation or the online help.

## Help and Support



For more information about troubleshooting, click **Start**, then click **Help and Support**. Type the keyword **troubleshooting** in the **Search** box  , then click the arrow.

# Troubleshooting

Troubleshooting topics are listed in alphabetical order.

## Audio

Audio troubleshooting is covered under [“Sound” on page 111](#).

## Battery

Battery troubleshooting is covered under [“Power” on page 109](#).

## CD drives

CD drive troubleshooting is covered under [“DVD drives” on page 97](#).

## Device installation

### You have computer problems after adding a new device

Sometimes a new device, such as a PC Card, can cause a system resource (IRQ) conflict. Check IRQ usage to determine if there is an IRQ conflict.



#### To check IRQ usage:

- 1 Click **Start**, then click **Control Panel**. The *Control Panel* window opens. If your Control Panel is in Category View, click **Performance and Maintenance**.
- 2 Click/Double-click **System**, click the **Hardware** tab, then click **Device Manager**. The *Device Manager* window opens.
- 3 Click **View**, then click **Resources by type**. Double-click **Interrupt request (IRQ)**. All IRQs and their hardware assignments are displayed.



**Help and Support**

For more information about IRQs, click **Start**, then click **Help and Support**. Type the keyword **IRQs** in the **Search** box  , then click the arrow.

 **To free IRQ resources for the new device:**

- 1** In the *Device Manager* window, check the device list for a resource conflict. A resource conflict appears as a black exclamation point in a yellow circle.
- 2** Remove the device you are trying to install, then determine which one of the existing devices or ports you can disable.
- 3** Right-click the device or port you want to disable, then click **Disable**. The device or port is disabled.



## Diskette drive

**The diskette drive is not recognized**

- Shut down and restart your notebook.

**You see an “Access Denied” or “Write protect” error message**

- Move the write-protection tab in the upper-right corner of the diskette down (unprotected).
- The diskette may be full. Delete unnecessary files on the diskette and try again.
- Not all diskettes are IBM-compatible. Make sure that the diskette you are using is IBM-compatible.
- Try a different diskette. Occasionally diskettes are flawed and cannot be read by the diskette drive.

**You see a “Disk is full” error message**

- Delete unnecessary files on the diskette.
- Try a different diskette. Occasionally diskettes are flawed and cannot be read by the diskette drive.

- Run Error checking on the diskette. If errors are detected and corrected, try using the diskette again.

#### Tips & Tricks



For instructions on running Error checking, see “Checking the hard drive for errors” in *Using Your Computer* which has been included on your hard drive. To access this guide, click **Start, All Programs**, then click **Gateway Documentation**.

### You see a “Non-system disk,” “NTLDR is missing,” or “Disk error” error message

- Eject the diskette from the diskette drive, then press ENTER.
- Make sure that the diskette you are using is IBM-compatible.

## Display

### The screen is too dark

Adjust the brightness using the system keys. For more information, see [“System key combinations” on page 34](#).

### The screen resolution is not correct

Change the screen resolution from the *Display Properties* dialog box.

#### Tips & Tricks



For instructions on changing the screen resolution, see “Adjusting the screen resolution” in *Using Your Computer* which has been included on your hard drive. To access this guide, click **Start, All Programs**, then click **Gateway Documentation**.

### The text on the display is dim or difficult to read

- Adjust the brightness and contrast using the system keys. For more information, see [“System key combinations” on page 34](#).
- Change the display settings.

#### Tips & Tricks



For instructions on changing the display settings, see “Adjusting the screen and desktop settings” in *Using Your Computer* which has been included on your hard drive. To access this guide, click **Start, All Programs**, then click **Gateway Documentation**.

- Move your notebook away from sources of electrical interference, such as televisions, unshielded speakers, microwaves, fluorescent lights, and metal beams or shelves.

### **The display has pixels that are always dark or too bright**

This condition is normal and inherent in the TFT technology used in active-matrix LCD screens. Gateway's inspection standards keep these to a minimum. If you feel these pixels are unacceptably numerous or dense on your display, contact Gateway Customer Care to identify whether a repair or replacement is justified based on the number of pixels affected.

## **DVD drives**

### **Your notebook does not recognize a disc**

- The disc may not be seated correctly in the tray. When you place a disc on the tray, make sure that you press the disc firmly onto the spindle so the retainers hold the disc in place.
- Make sure that the disc label is facing up, then try again.
- If you are trying to play a DVD, make sure that you have a DVD drive. See ["Identifying drive types" on page 44](#) for more information.
- Try a different disc. Occasionally discs are flawed and cannot be read by the drive.
- Some music CDs have copy protection software. You may not be able to play these CDs on your notebook.
- Your notebook may be experiencing some temporary memory problems. Shut down and restart your notebook.
- Clean the disc. For more information, see ["Cleaning CDs or DVDs" on page 86](#).

### **An audio CD does not produce sound**

- Make sure that the CD label is facing up, then try again.
- Some music CDs have copy protection software. You may not be able to play these CDs on your notebook.
- Make sure that the volume control on your notebook is turned up. For more information, see ["System key combinations" on page 34](#).
- Make sure that the Windows volume control is turned up.

### Tips & Tricks



For instructions on how to adjust the volume control in Windows, see “Adjusting the volume” in *Using Your Computer* which has been included on your hard drive. To access this guide, click **Start, All Programs**, then click **Gateway Documentation**.

- Make sure that Mute controls are turned off. For more information about the mute setting, see [“System key combinations” on page 34](#).
- Make sure that headphones are not plugged into the headphone jack.
- If you are using powered speakers, make sure that they are plugged in and turned on.
- Clean the disc. For more information, see [“Cleaning CDs or DVDs” on page 86](#).
- Your notebook may be experiencing some temporary memory problems. Shut down and restart your notebook.
- Reinstall the audio device drivers. For more information, see [“Downloads” on page 4](#).

### A DVD movie will not play

- Make sure that the label or side you want to play is facing up, then try again.
- Make sure that you have a DVD drive. See [“Identifying drive types” on page 44](#) for more information.
- Shut down and restart your notebook.
- Clean the DVD. For more information, see [“Cleaning CDs or DVDs” on page 86](#).
- DVD discs and drives contain *regional codes* that help control DVD title exports and help reduce illegal disc distribution. To be able to play a DVD, the disc’s regional code and your DVD drive’s regional code must match.

The regional code on your DVD drive is determined by your notebook’s delivery address. The regional code for the United States and Canada is 1. The regional code for Mexico is 4. Your DVD drive’s regional code must match the regional code of the disc. The regional code for the disc is on the disc, disc documentation, or packaging.



If the DVD movie does not play, the disc's regional code and your DVD drive's regional code may not match.

- Make sure that a DVD player program has been installed on your notebook.

### Tips & Tricks



For instructions on playing a DVD, see [“Playing a DVD” on page 46](#).

## File management

### A file was accidentally deleted

If a file was deleted at a DOS prompt or in Windows while holding down the **SHIFT** key, the file cannot be restored.



### To restore deleted files:

- 1 Double-click the **Recycle Bin** icon.
- 2 Right-click the file you want to restore, then click **Restore**. The file is restored to the place where it was originally deleted from.

If the Recycle Bin was emptied before you tried to restore a file, the file cannot be restored.



### Help and Support



For more information about restoring deleted files, click **Start**, then click **Help and Support**. Type the keyword **System Restore** in the **Search** box

Search  , then click the arrow.

## Hard drive

### You see an “Insufficient disk space” error message

- Delete unnecessary files from the hard drive using Disk Cleanup.

**Tips & Tricks**



For instructions on deleting unnecessary files, see “Using Disk Cleanup” in *Using Your Computer* which has been included on your hard drive. To access this guide, click **Start, All Programs**, then click **Gateway Documentation**.

- Empty the Recycle Bin by right-clicking the **Recycle Bin** icon, then clicking **Empty Recycle Bin**.

**Caution**



All deleted files will be lost when you empty the Recycle Bin.

- Save your files to a diskette, USB flash drive, or to a CD. If the hard drive is full, copy any files not regularly used to backup media, then delete them from the hard drive.

**Help and Support**



For more information about file management, click **Start**, then click **Help and Support**. Type the keyword **file management** in the **Search** box  , then click the arrow.

**You see a “Data error” message**

This may be the result of a defective area on the hard drive. To fix hard drive problems, run the Error checking program.

**Tips & Tricks**



For instructions on fixing hard drive problems, see “Checking the hard drive for errors” in *Using Your Computer* which has been included on your hard drive. To access this guide, click **Start, All Programs**, then click **Gateway Documentation**.

**The hard drive cannot be accessed, or you see a “General failure reading drive C” error message**

- If a diskette is in the diskette drive, eject it and restart your notebook.
- Make sure that the hard drive is installed correctly. Remove it, firmly reinsert it, then restart your notebook. For more information, see [“Replacing the hard drive kit” on page 70](#).
- If your notebook has been subjected to static electricity or physical shock, you may need to reinstall the operating system.

## You see a “Non-system disk,” “NTLDR is missing,” or “disk” error message

- Eject the diskette from the diskette drive, then press ENTER.

# Internet

## You cannot connect to the Internet

- If you are using a dial-up modem, make sure that the modem cable is plugged into the modem jack and not the Ethernet network jack. See “Back” on page 14 or “Back” on page 78 to make sure that the connections have been made correctly.

-OR-

If you are using a cable or DSL modem, make sure that the modem cable is plugged into the Ethernet network jack and not the modem jack. See “Back” on page 14 or “Back” on page 78 to make sure that the connections have been made correctly.

- Make sure that you do not have a problem with your modem. For more information, see “Modem (dial-up)” on page 104.
- Make sure that your account with your Internet service provider (ISP) is set up correctly. Contact your ISP technical support for help.

### Help and Support



For more information about troubleshooting Internet connections, click **Start**, then click **Help and Support**. Type the keyword **troubleshooting connections** in the **Search** box  , then click the arrow.

## You see an “Unable to locate host” message and are unable to browse the Internet

This problem can occur when you have typed a URL (Web address) incorrectly, you have lost your Internet connection, or your ISP is having technical difficulties.

Double-check the URL or try a different URL. If the error message still appears, disconnect from the ISP connection and close your browser, then reconnect and open the browser. If you still get the error, your ISP may be having technical difficulties.

### **Connecting to a Web site takes too long**

Many factors can affect Internet performance:

- The condition of the telephone lines in your residence or at your local telephone service
- The condition of the Internet computers to which you connect and the number of users accessing those computers
- The complexity of graphics and multimedia on Web pages
- Having multiple Web browsers open, performing multiple downloads, and having multiple programs open on your notebook

### **People are sending you e-mail messages, but you have not received any mail**

- Click the receive button in your e-mail program.
- Make sure that your account with your Internet service provider (ISP) is set up correctly. Contact your ISP for technical support.

## **Keyboard**

### **The built-in keyboard does not work**

- Attaching a PS/2 keyboard to your port replicator while your notebook is running may deactivate the built-in keyboard.

### **The external keyboard does not work**

- Make sure that the keyboard cable is plugged in correctly.
- Remove all extension cables and switchboxes.
- Clean the keyboard by using an aerosol can of air with a narrow, straw-like extension to remove dust and lint trapped under the keys.
- Try a keyboard that you know works to make sure that the keyboard port works.
- If you spilled liquid in the keyboard, turn off your notebook and unplug the keyboard. Clean the keyboard and turn it upside down to drain it. Let the keyboard dry before using it again. If the keyboard does not work after it dries, you may need to replace it.

### A keyboard character keeps repeating or you see a “Keyboard stuck” or “Key failure” error message

- Make sure that nothing is resting on the keyboard.
- Make sure that a key is not stuck. Press each key to loosen a key that might be stuck, then restart your notebook.

### You are pressing a letter key and a number appears on the screen

- The numeric keypad is turned on. See [“System key combinations” on page 34](#) for instructions on turning off your numeric keypad.

## Memory

### You see a “Memory error” message

- Make sure that the memory modules are inserted correctly in the memory bay slots. For more information, see [“Adding or replacing memory” on page 67](#).
- Use a third-party diagnostic program to help determine if a memory module is failing. For more information, see [“Adding or replacing memory” on page 67](#).

### You see a “Not enough memory” error message

Close all programs, then restart your notebook.

#### Help and Support



For more information about troubleshooting memory errors, click **Start**, then click **Help and Support**. Type the keyword **memory error** in the **Search** box  , then click the arrow.

## Memory card reader

### Drive letter for the memory card slot does not appear in the My Computer window

- Reboot your notebook.

## Modem (dial-up)

### Your modem does not dial or does not connect

- Make sure that the modem cable is plugged into the modem jack and not the Ethernet network jack. See “Back” on page 14 to make sure that the connections have been made correctly.
- Make sure that your notebook is connected to the telephone line and the telephone line has a dial tone.
- Make sure that the modem cable is less than 6 feet (1.8 meters) long.
- Remove any line splitters or surge protectors from your telephone line, then check for a dial tone by plugging a working telephone into the telephone wall jack.
- If you have additional telephone services such as call waiting, call messaging, or voice mail, make sure that all messages are cleared and call waiting is disabled before using the modem. Contact your telephone service to get the correct code to temporarily disable the service. Also make sure that the modem dialing properties are set appropriately.



### To check the dialing properties:

- 1 Click **Start**, then click **Control Panel**. The *Control Panel* window opens. If your Control Panel is in Category View, click **Printers and Other Hardware**.
- 2 Click/Double-click the **Phone and Modem Options** icon, then click the **Dialing Rules** tab.
- 3 Click the location from which you are dialing, then click **Edit**.
- 4 Make sure that all settings are correct.



### Help and Support



For more information about dialing properties, click **Start**, then click **Help and Support**. Type the keyword **dialing** in the **Search** box  , then click the arrow.

- Disconnect any answering machine, fax machine, or printer that is on the same line as the modem. Do not connect these devices to the same telephone line as the modem.
- Make sure that you are not using a digital, rollover, or PBX line. These lines do not work with your modem.
- Check for line noise (scratchy, crackling, or popping sounds). Line noise is a common problem that can cause the modem to connect at a slower rate, abort downloads, or even disconnect. The faster the modem, the less line noise it can tolerate and still work correctly.

Listen to the line using your telephone. Dial a single number (such as 1). When the dial tone stops, listen for line noise. Wiggle the modem cable to see if that makes a difference. Make sure that the connectors are free from corrosion and all screws in the wall or telephone wall jack are secure.

You can also call your telephone service and have the telephone line checked for noise or low line levels.

- Try another telephone line (either a different telephone number in your house or a telephone line at a different location). If you can connect on this line, call your telephone service.
- Try connecting with the modem at a lower connection speed. If reducing the connect speed lets you connect, call your telephone service. The telephone line may be too noisy.

### **You cannot connect to the Internet**

- The ISP may be having technical difficulties. Contact your ISP for technical support.
- See if the modem works with a different communications program. The problem may be with just one program.
- Review the troubleshooting information under [“Internet” on page 101](#).

### **You 56K modem does not connect at 56K**

Current FCC regulations restrict actual data transfer rates over public telephone lines to 53K. Other factors, such as line noise, telephone service provider equipment, or ISP limitations, may lower the speed even further.

If your notebook has a v.90 modem, the speed at which you can upload (send) data is limited to 33.6K. If your notebook has a v.92 modem, the speed at which you can upload data is limited to 48K. Your ISP may not support 48K uploads.

### **Your fax communications program only sends and receives faxes at 14,400 bps when you have a 56K modem**

Current fax technology only supports a maximum send and receive rate of 14,400 bps.

### **The modem is not recognized by your notebook**

- Make sure that the line connected to the modem is working and plugged into the appropriate port on your notebook. See [“Back” on page 14](#) to make sure that the connections have been made correctly.
- If the modem shares the telephone line with another device, make sure that the telephone line is not in use (for example, someone is on the telephone, or another modem is in use).
- Use the modem cable that came with your notebook. Some telephone cables do not meet required cable standards and may cause problems with the modem connection.
- Shut down and restart your notebook.
- Run Windows modem diagnostics.



#### **To run modem diagnostics:**

- 1** Close all open programs.
- 2** Click **Start**, then click **Control Panel**. The *Control Panel* window opens. If your Control Panel is in Category View, click **Printers and Other Hardware**.
- 3** Click/Double-click the **Phone and Modem Options** icon, then click the **Modems** tab.
- 4** Click your modem, then click **Properties**. The *Modem Properties* dialog box opens.



- 5 Click the **Diagnostic** tab, then click **Query Modem**. If information about the modem appears, the modem passed diagnostics. If no modem information is available, a white screen appears with no data, or if you get an error such as *port already open* or *the modem has failed to respond*, the modem did not pass diagnostics.



### Help and Support



For more information about modem troubleshooting, click **Start**, then click **Help and Support**. Type the keyword **modem troubleshooting** in the **Search** box  , then click the arrow.

## The modem is noisy when it dials and connects

When your modem tries to connect to another modem, it begins *handshaking*. Handshaking is a digital “getting acquainted” conversation between the two modems that establishes connection speeds and communication protocols. You may hear unusual handshaking sounds when the modems first connect. If the handshaking sounds are too loud, you can turn down the modem volume.

### To turn down the modem volume:

- 1 Click **Start**, then click **Control Panel**. The *Control Panel* window opens. If your Control Panel is in Category View, click **Printers and Other Hardware**.
- 2 Click/Double-click the **Phone and Modem Options** icon, then click the **Modems** tab.
- 3 Click the modem you want to adjust, then click **Properties**.
- 4 Click the **Modem** tab, then adjust the **Speaker volume** control.
- 5 Click **OK** twice to close the *Phone and Modem Options* dialog box.



## Mouse

### The external mouse does not work

- Make sure that the mouse cable is plugged in correctly.

- Shut down and restart your notebook.
- Remove all extension cables and switch boxes.
- Try a mouse you know is working to make sure that the mouse port works.

### The external mouse works erratically

- Clean the mouse.
- Some mouse pad patterns “confuse” optical mice. Try the mouse on a different surface.

## Networks

### You cannot connect to your company network

Every network is unique. Contact your company computer department or network administrator for help

#### Tips & Tricks



For information about setting up a network in your home, see the network guide which has been included on your hard drive. To access this guide, click **Start**, **All Programs**, then click **Gateway Documentation**.

#### Help and Support



For more information about network troubleshooting, click **Start**, then click **Help and Support**. Type the keyword **network troubleshooting** in the **Search** box  , then click the arrow.

## Passwords

### Your notebook does not accept your password

Make sure that CAPS LOCK and NUM LOCK are turned off, then retype the password.

### You forgot your startup password

The password feature (which is set in the BIOS Setup utility) is very secure, with no easy way to recover a forgotten password. You must return your notebook for repair. Call Gateway Customer Care for instructions.

## PC Cards

### **You installed a PC Card and now your notebook is having problems**

- Make sure that you have correctly installed required software for the PC Card. For more information, see your PC Card's documentation.
- Make sure that the PC Card you installed is not causing a system resource conflict. For more information on resource conflicts, see [“Device installation” on page 94](#).

## Power

### **Your notebook is not working on AC power**

- Make sure that your AC power adapter is connected correctly to your notebook. For more information, see [“Connecting the AC adapter” on page 24](#).
- If your notebook is plugged into a surge protector, make sure that the surge protector is connected securely to an electrical outlet, turned on, and working correctly. To test the outlet, plug a working device, such as a lamp, into the outlet and turn it on.
- Make sure that the AC power adapter cables are free from cuts or damage. Replace any damaged cables.

### **Your notebook is not working on battery power**

- Make sure that the battery is installed correctly. For more information, see [“Changing batteries” on page 60](#).
- Make sure that the battery is fully recharged. For more information, see [“Recharging the battery” on page 58](#).
- Make sure that the battery is calibrated correctly. For more information, see [“Recalibrating the battery” on page 59](#).

## Printer

### **The printer will not turn on**

- Make sure that the printer is online. Many printers have an online/offline button that you may need to press.
- Make sure that the power cable is plugged into an AC power source.

### The printer is on but will not print

- Check the cable between the printer and your notebook. Make sure that it is connected to the correct port.
- Make sure that the printer is online. Many printers have an online/offline button that you may need to press so the printer can start printing. Press the button to put the printer online.
- Check the port and cable for bent or broken pins.
- If the printer you want to print to is not the default printer, make sure that you have selected it in the printer setup.

#### To set a default printer:

- 1 Click **Start**, then click **Control Panel**. The *Control Panel* window opens. If your Control Panel is in Category View, click **Printers and Other Hardware**.
- 2 Click/Double-click the **Printers and Faxes** icon. The *Printers and Faxes* window opens.
- 3 Right-click the name of the printer you want to be the default printer, then click **Set as Default Printer**.



- Reinstall the printer driver. See the guide that came with your printer for instructions on installing the printer driver.

### You see a “Printer queue is full” error message

- Make sure that the printer is not set to work offline.

#### To make sure that the printer is not set to work offline:

- 1 Click **Start**, then click **Control Panel**. The *Control Panel* window opens. If your Control Panel is in Category View, click **Printers and Other Hardware**.
- 2 Click/Double-click the **Printers and Faxes** icon. The *Printers and Faxes* window opens.

- 3 Right-click the name of the printer you want to use. If the menu shows a check mark next to **Use Printer Offline**, click **Use Printer Offline** to clear the check mark.



### Help and Support



For more information about printer troubleshooting, click **Start**, then click **Help and Support**. Type the keyword **printer troubleshooter** in the **Search** box  , then click the arrow.

- Wait until files have been printed before sending additional files to the printer.
- If you print large files or many files at one time, you may want to add additional memory to the printer. See the printer documentation for instructions for adding additional memory.

### You see a “Printer is out of paper” error message

After adding paper, make sure that the printer is online. Most printers have an online/offline button that you need to press after adding paper.

## Sound

### You are not getting sound from the built-in speakers

- Make sure that headphones are not plugged into the headphone jack.
- Make sure that the volume control on your notebook is turned up. For more information, see [“System key combinations” on page 34](#).
- Make sure that the Windows volume control is turned up.

### Tips & Tricks



For instructions on how to adjust the volume control in Windows, see “Adjusting the volume” in *Using Your Computer* which has been included on your hard drive. To access this guide, click **Start**, **All Programs**, then click **Gateway Documentation**.

- Make sure that Mute controls are turned off. For more information about the mute setting, see [“System key combinations” on page 34](#).

**Help and Support**



For more information about troubleshooting sound issues, click **Start**, then click **Help and Support**. Type the keyword **sound troubleshooter** in the **Search** box

Search  , then click the arrow.

## Touchpad

### **The touchpad does not work.**

Attaching a PS/2 mouse to your port replicator may deactivate the touchpad.

## Video

### **The projector or external monitor is not working**

- Make sure that you have pressed FN+F3 to activate the external monitor option.
- Make sure that the monitor is turned on and that the video cable is connected correctly.

# Telephone support

## Before calling Gateway Customer Care

If you have a technical problem with your notebook, follow these recommendations before contacting Gateway Customer Care:

- Make sure that your notebook is connected correctly to a grounded AC outlet that is supplying power. If you use a surge protector, make sure that it is turned on.
- If a peripheral device, such as a keyboard or mouse, does not appear to work, make sure that all cables are plugged in securely.
- If you have recently installed hardware or software, make sure that you have installed it according to the instructions provided with it. If you did not purchase the hardware or software from Gateway, see the manufacturer's documentation and technical support resources.
- If you have "how to" questions about using a program, see:
  - Online Help
  - Printed documentation
  - The Microsoft Windows documentation
  - The software publisher's Web site
- See the troubleshooting section of this chapter.

### Warning



To avoid bodily injury, do not attempt to troubleshoot your notebook problem if:

- Power cords or plugs are damaged
- Liquid has been spilled into your notebook
- Your notebook was dropped
- The case was damaged

Instead, unplug your notebook and contact a qualified computer technician.

- Have your customer ID, serial number, and order number available, along with a detailed description of your problem, including the exact text of any error messages, and the steps you have taken.
- Make sure that your notebook is nearby at the time of your call. The technician may have you follow troubleshooting steps.

## Telephone numbers

Gateway offers a wide range of customer service, customer care, and information services.

### Automated troubleshooting system

Service description	How to reach
Use an automated menu system and your telephone keypad to find answers to common problems.	800-846-2118

### Telephone numbers

You can access the following services through your telephone to get answers to your questions:

Resource	Service description	How to reach
Gateway's fee-based software tutorial service	Get tutorial assistance for software issues billed by the minute.	800-229-1103 (charged to your credit card) 900-555-4695 (charged to your telephone bill)
Gateway Customer Care	Talk to a Gateway Customer Care representative about a non-tutorial technical support question. (See <a href="#">“Before calling Gateway Customer Care” on page 113</a> before calling.)	Gateway Customer Care telephone numbers vary by country or region. For the correct telephone number, see your setup poster or the Gateway eSupport Web site at <a href="http://support.gateway.com">support.gateway.com</a> . For more information, see <a href="#">“Using eSupport” on page 4</a> .
America Online	Get support for your America Online ISP account	800-827-6364 (US) 888-265-4357 (Canada)
Sales, accounting, and warranty	Get information about available systems, pricing, orders, billing statements, warranty service, or other non-technical issues.	800-846-2000 (US) 888-387-7752 (Canada)



# Appendix A

---

## Safety, Regulatory, and Legal Information



- Safety information
- Regulatory statements
- Notices

# Important safety information

Your Gateway system is designed and tested to meet the latest standards for safety of information technology equipment. However, to ensure safe use of this product, it is important that the safety instructions marked on the product and in the documentation are followed.

## Warning



Always follow these instructions to help guard against personal injury and damage to your Gateway system.

## Setting up your system

- Read and follow all instructions marked on the product and in the documentation before you operate your system. Retain all safety and operating instructions for future use.
- Do not use this product near water or a heat source such as a radiator.
- Set up the system on a stable work surface.
- The product should be operated only from the type of power source indicated on the rating label.
- If your notebook has a voltage selector switch, make sure that the switch is in the proper position for your area. The voltage selector switch is set at the factory to the correct voltage.
- Openings in the notebook case are provided for ventilation. Do not block or cover these openings. Make sure you provide adequate space, at least 6 inches (15 cm), around the system for ventilation when you set up your work area. Never insert objects of any kind into the notebook ventilation openings.
- Some products are equipped with a three-wire power cord to make sure that the product is properly grounded when in use. The plug on this cord will fit only into a grounding-type outlet. This is a safety feature. If you are unable to insert the plug into an outlet, contact an electrician to install the appropriate outlet.
- If you use an extension cord with this system, make sure that the total ampere rating on the products plugged into the extension cord does not exceed the extension cord ampere rating.
- If your system is fitted with a TV Tuner, cable, or satellite receiver card, make sure that the antenna or cable system is electrically grounded to provide some protection against voltage surges and buildup of static charges.

## Care during use

- Do not walk on the power cord or allow anything to rest on it.
- Do not spill anything on the system. The best way to avoid spills is to avoid eating and drinking near your system.
- Some products have a replaceable CMOS battery on the system board. There is a danger of explosion if the CMOS battery is replaced incorrectly. Replace the battery with the same or equivalent type recommended by the manufacturer. Dispose of batteries according to the manufacturer's instructions.

- When the notebook is turned off, a small amount of electrical current still flows through the notebook. To avoid electrical shock, always unplug all power cables and modem cables from the wall outlets before cleaning the system.
- Unplug the system from the wall outlet and refer servicing to qualified personnel if:
  - The power cord or plug is damaged.
  - Liquid has been spilled into the system.
  - The system does not operate properly when the operating instructions are followed.
  - The system was dropped or the cabinet is damaged.
  - The system performance changes.

## Replacement parts and accessories

Use only replacement parts and accessories recommended by Gateway.

### Warning



Do not use Gateway products in areas classified as hazardous locations. Such areas include patient care areas of medical and dental facilities, oxygen-laden environments, or industrial facilities.

### Warning



To reduce the risk of fire, use only No. 26 AWG or larger telecommunications line cord.

# Regulatory compliance statements

## Wireless Guidance

Low power, Radio transmitting type devices (radio frequency (RF) wireless communication devices), may be present (embedded) in your notebook system. These devices may operate in the 2.4 GHz (i.e. 802.11B/G LAN & Bluetooth), 5.2 GHz (i.e. 802.11A LAN), and traditional cellular or PCS cellular bands (i.e. Cellular data modem). The following section is a general overview of considerations while operating a wireless device.

Additional limitations, cautions, and concerns for specific countries are listed in the specific country sections (or country group sections). The wireless devices in your system are only qualified for use in the countries identified by the Radio Approval Marks on the system rating label. If the country you will be using the wireless device in, is not listed, please contact your local Radio Approval agency for requirements. Wireless devices are closely regulated and use may not be allowed.

The power output of the wireless device or devices that may be embedded in your notebook is well below the RF exposure limits as known at this time. Because the wireless devices (which may be embedded into your notebook) emit less energy than is allowed in

radio frequency safety standards and recommendations, Gateway believes these devices are safe for use. Regardless of the power levels, care should be taken to minimize human contact during normal operation.

Measurements have been performed to show that the RF exposure is below what is considered safe limits; however care should be taken to make sure the user or bystanders keep the transmitter away from their body when the wireless device is transmitting. The transmitting antenna installed in the top third of the lid should be used in a manner to maintain 20 cm (8 inches) from user's or bystander's bodies.

The wireless devices installed in this system are intended to be used indoors. In some areas, use of these devices outdoors is prohibited.

Some circumstances require restrictions on wireless devices. Examples of common restrictions are listed below:

### Warning



Radio frequency wireless communication can interfere with equipment on commercial aircraft. Current aviation regulations require wireless devices to be turned off while traveling in an airplane. 802.11B (also known as wireless Ethernet or Wifi) and Bluetooth communication devices are examples of devices that provide wireless communication.

### Warning



In environments where the risk of interference to other devices or services is harmful or perceived as harmful, the option to use a wireless device may be restricted or eliminated. Airports, Hospitals, and Oxygen or flammable gas laden atmospheres are limited examples where use of wireless devices may be restricted or eliminated. When in environments where you are uncertain of the sanction to use wireless devices, ask the applicable authority for authorization prior to use or turning on the wireless device.

### Warning



If your system came equipped with an internal embedded wireless device, do not operate the wireless device unless all covers and shields are in place and the system is fully assembled.

### Caution



Wireless devices are not user serviceable. Do not modify them in any way. Modification to a wireless device will void the authorization to use it. Please contact Gateway for service.

**Caution**

Only use drivers approved for the country in which the device will be used. See the Gateway System Restoration Kit, or contact Gateway Customer Care for additional information.

**Important**

Every country has different restrictions on the use of wireless devices. Since your system is equipped with a wireless device, when traveling between countries with your system, check with the local Radio Approval authorities prior to any move or trip for any restrictions on the use of a wireless device in the destination country.

## United States of America

### Federal Communications Commission (FCC) Intentional emitter per FCC Part 15

Low power, Radio transmitter type devices (radio frequency (RF) wireless communication devices), operating in the 2.4 GHz band and/or 5.15 – 5.35 GHz band, may be present (embedded) in your notebook system. This section is only applicable if these devices are present. Refer to the system label to verify the presence of wireless devices.

Wireless devices that may be in your system are only qualified for use in the United States of America if an FCC ID number is on the system label.

The FCC has set a general guideline of 20 cm (8 inches) separation between the device and the body, for use of a wireless device near the body (this does not include extremities). This device should be used more than 20 cm (8 inches) from the body when wireless devices are on. The power output of the wireless device (or devices), which may be embedded in your notebook, is well below the RF exposure limits as set by the FCC.

The wireless devices installed in this system are intended to be used indoors. In some areas, use of these devices outdoors is prohibited.

Operation of this device is subject to the following two conditions: (1) This device may not cause harmful interference, and (2) this device must accept any interference received, including interference that may cause undesired operation of the device.

**Caution**

Wireless devices are not user-serviceable. Do not modify them in any way. Modification to a wireless device will void the authorization to use it. Contact Gateway for service.

**Caution**

The transmitting device embedded in this system may not be used with any antenna other than the one provided with the system.

**Caution**



In order to comply with FCC requirements this transmitter must not be operated (or co-located) in conjunction with any other transmitter or antenna installed in the notebook.

**Unintentional emitter per FCC Part 15**

This device has been tested and found to comply with the limits for a Class B digital device, pursuant to Part 15 of the FCC rules. These limits are designed to provide reasonable protection against harmful interference in a residential installation. This equipment generates, uses, and can radiate radio frequency energy and, if not installed and used in accordance with the instructions, may cause harmful interference to radio or television reception. However, there is no guarantee that interference will not occur in a particular installation. If this equipment does cause interference to radio and television reception, which can be determined by turning the equipment off and on, the user is encouraged to try to correct the interference by one or more of the following measures:

- Reorient or relocate the receiving antenna
- Increase the separation between the equipment and receiver
- Connect the equipment into an outlet on a circuit different from that to which the receiver is connected
- Consult the dealer or an experienced radio/TV technician for help.

**Compliance Accessories:** The accessories associated with this equipment are: shielded video cable when an external monitor is connected. These accessories are required to be used in order to ensure compliance with FCC rules.

**FCC declaration of conformity**

**Responsible party:**

Gateway Companies, Inc.  
610 Gateway Drive, North Sioux City, SD 57049  
(605) 232-2000 Fax: (605) 232-2023

**Product:**

- Gateway M405

This device complies with Part 15 of the FCC Rules. Operation of this product is subject to the following two conditions: (1) this device may not cause harmful interference, and (2) this device must accept any interference received, including interference that may cause undesired operation.

**Caution**



Changes or modifications not expressly approved by Gateway could void the FCC compliance and negate your authority to operate the product.

**California Proposition 65 Warning**

**Warning**



This product contains chemicals, including lead, known to the State of California to cause cancer, birth defects or reproductive harm.

## Mercury Warning

### Warning



The lamp in this display contains mercury. Do not put in the trash. Recycle or dispose as hazardous waste.

## Telecommunications per Part 68 of the Code of Federal Regulations (CFR 47) (applicable to products fitted with USA modems)

Your modem complies with Part 68 of the Code of Federal Regulations (CFR 47) rules. On the computer or modem card is a label that contains the FCC registration number and Ringer Equivalence Number (REN) for this device. If requested, this information must be provided to the telephone company.

A telephone line cord with a modular plug is required for use with this device. The modem is designed to be connected to the telephone network or premises wiring using a compatible modular jack which is Part 68-compliant. See installation instructions for details.

The Ringer Equivalence Number (REN) is used to determine the number of devices which may be connected to the telephone line. Excessive RENs on a telephone line may result in the devices not ringing in response to an incoming call. In most areas, the sum of RENs should not exceed five (5.0). To be certain of the number of devices that may be connected to a line, as determined by the total RENs, contact the local telephone company.

If this device causes harm to the telephone network, the telephone company will notify you in advance that temporary discontinuance of service may be required. The telephone company may request that you disconnect the equipment until the problem is resolved.

The telephone company may make changes in its facilities, equipment, operations, or procedures that could affect the operation of this equipment. If this happens, the telephone company will provide advance notice in order for you to make necessary modifications to maintain uninterrupted service.

This equipment cannot be used on telephone company-provided coin service. Connection to party line service is subject to state tariffs. Contact the state public utility commission or public service commission for information.

When programming or making test calls to emergency numbers:

- Remain on the line and briefly explain to the dispatcher the reason for the call.
- Perform such activities in the off-peak hours such as early morning or late evenings.

The United States Telephone Consumer Protection Act of 1991 makes it unlawful for any person to use a computer or other electronic device to send any message via a telephone fax machine unless such message clearly contains, in a margin at the top or bottom of each transmitted page or on the first page of the transmission, the date and time it is sent, an identification of the business, other entity, or other individual sending the message, and the telephone number of the sending machine or such business, other entity, or individual. Refer to your fax communication software documentation for details on how to comply with the fax-branding requirement.

# Canada

## Industry Canada (IC) Intentional emitter per RSS 210

Low power, Radio transmitter type devices (radio frequency (RF) wireless communication devices), operating in the 2.4 GHz band and/or 5.15 – 5.35 GHz band, may be present (embedded) in your notebook system. This section is only applicable if these devices are present. Refer to the system label to verify the presence of wireless devices.

Wireless devices that may be in your system are only qualified for use in Canada if an Industry Canada ID number is on the system label.

As a general guideline, a separation of 20 cm (8 inches) between the wireless device and the body, for use of a wireless device near the body (this does not include extremities) is typical. This device should be used more than 20 cm (8 inches) from the body when wireless devices are on. The power output of the wireless device (or devices), which may be embedded in your notebook, is well below the RF exposure limits as set by Industry Canada.

Operation of this device is subject to the following two conditions: (1) This device may not cause harmful interference, and (2) this device must accept any interference received, including interference that may cause undesired operation of the device.

### Caution



To prevent radio interference to licensed service or co-channel Mobile Satellite systems, this device is intended to be operated indoors and away from windows to provide maximum shielding. Equipment (or its transmit antenna) that is installed outdoors is subject to licensing.

### Caution



Wireless devices are not user-serviceable. Do not modify them in any way. Modification to a wireless device will void the authorization to use it. Contact Gateway for service.

### Caution



The transmitting device embedded in this system may not be used with any antenna other than provide with the system.

### Caution



The 802.11A radio LAN your system may have been equipped with operates in the same frequency range as high power radar, which has priority use, and may damage the radio LAN if both are present and being used in the same area.

## Unintentional emitter per ICES-003

This digital apparatus does not exceed the Class B limits for radio noise emissions from digital apparatus as set out in the radio interference regulations of Industry Canada.



Le présent appareil numérique n'émet pas de bruits radioélectriques dépassant les limites applicables aux appareils numériques de Classe B prescrites dans le règlement sur le brouillage radioélectrique édicté par Industrie Canada.

### Telecommunications per Industry Canada CS-03 (for products fitted with an IC-compliant modem)

The Industry Canada label identifies certified equipment. This certification means that the equipment meets certain telecommunications network protective, operation, and safety requirements. The Department does not guarantee the equipment will operate to the users' satisfaction.

Before installing this equipment, users should make sure that it is permissible to be connected to the facilities of the local telecommunications company. The equipment must also be installed using an acceptable method of connection. In some cases, the inside wiring associated with a single-line individual service may be extended by means of a certified connector assembly. The customer should be aware that compliance with the above conditions may not prevent degradation of service in some situations.

Repairs to certified equipment should be made by an authorized Canadian maintenance facility designated by the supplier. Any repairs or alterations made by the user to this equipment, or equipment malfunctions, may give the telecommunications company cause to request the user to disconnect the equipment.

Users should make sure, for their own protection, that the electrical ground connections of the power utility, telephone lines, and internal metallic water pipe system, if present, are connected together. This precaution may be particularly important in rural areas.

#### Warning



To avoid electrical shock or equipment malfunction do not attempt to make electrical ground connections by yourself. Contact the appropriate inspection authority or an electrician, as appropriate.

The **Ringer Equivalence Number** (REN) assigned to each terminal device provides an indication of the maximum number of terminals allowed to be connected to a telephone interface. The termination on an interface may consist of any combination of devices subject only to the requirement that the sum of the Ringer Equivalence Numbers of all the devices does not exceed 5.

## Laser safety statement

All Gateway systems equipped with CD and DVD drives comply with the appropriate safety standards, including IEC 825. The laser devices in these components are classified as "Class 1 Laser Products" under a US Department of Health and Human Services (DHHS) Radiation Performance Standard. Should the unit ever need servicing, contact an authorized service location.

**Warning**



Use of controls or adjustments or performance of procedures other than those specified in this manual may result in hazardous radiation exposure. To prevent exposure to laser beams, do not try to open the enclosure of a CD or DVD drive.

## EPA ENERGY STAR



As an ENERGY STAR® Partner, Gateway has determined that this product meets the ENERGY STAR guidelines for energy efficiency when used with a computer equipped with a Display Power Management System.

# Notices

Copyright © 2004 Gateway, Inc.  
All Rights Reserved  
14303 Gateway Place  
Poway, CA 92064 USA

## All Rights Reserved

This publication is protected by copyright and all rights are reserved. No part of it may be reproduced or transmitted by any means or in any form, without prior consent in writing from Gateway.

The information in this manual has been carefully checked and is believed to be accurate. However, changes are made periodically. These changes are incorporated in newer publication editions. Gateway may improve and/or change products described in this publication at any time. Due to continuing system improvements, Gateway is not responsible for inaccurate information which may appear in this manual. For the latest product updates, consult the Gateway Web site at [www.gateway.com](http://www.gateway.com). In no event will Gateway be liable for direct, indirect, special, exemplary, incidental, or consequential damages resulting from any defect or omission in this manual, even if advised of the possibility of such damages.

In the interest of continued product development, Gateway reserves the right to make improvements in this manual and the products it describes at any time, without notices or obligation.

## Trademark Acknowledgments

Gateway and the Black-and-White Spot Design are trademarks or registered trademarks of Gateway, Inc. in the U.S. and other countries. SpotShop, SpotsShop.com, and Your:)Ware are trademarks of Gateway, Inc. Intel, Intel Inside logo, and Pentium are registered trademarks and MMX is a trademark of Intel Corporation. Microsoft, MS, MS-DOS, and Windows are trademarks or registered trademarks of Microsoft Corporation. All other product names mentioned herein are used for identification purposes only, and may be the trademarks or registered trademarks of their respective companies.

## Macrovision statement

**If your notebook has a DVD drive and an analog TV Out port, the following paragraph applies:**

This product incorporates copyright protection technology that is protected by method claims of certain U.S. patents and other intellectual property rights owned by Macrovision Corporation and other rights owners. Use of this copyright protection technology must be authorized by Macrovision Corporation, and is intended for home and other limited viewing uses only unless otherwise authorized by Macrovision Corporation. Reverse engineering or disassembly is prohibited.



# Index

## A

- AC adapter
  - connecting 24
  - connector 14, 77, 79
  - international adapters 63
- AC-3 digital audio jack 79
- accessories
  - purchasing 21
  - safety precautions 117
- airplane power adapter 21
- application key 32, 33
- arrow keys 32, 33
- audio
  - adjusting volume 35
  - digital jack 79
  - headphone jack 11
  - microphone jack 11
  - muting 35, 40
  - troubleshooting 111
  - volume down button 35
  - volume up button 35
- audio CD
  - cleaning 86
  - playing 46
- automobile power adapter 21, 63

## B

- battery
  - alternate power sources 63
  - bay 15, 60
  - changing 60
  - charge indicator 10, 56
  - charge status 56
  - charging 24, 58
  - conserving power 62
  - icons 56
  - installing 60
  - latch 15
  - managing power 62

- meter 57
- monitoring charge 56
- purchasing 21
- recalibrating 59
- recharging 24, 58
- release latch 15
- replacing 60

## bays

- battery 15, 60
- hard drive 15
- memory 15, 67

## BIOS Setup utility 59

## break system key 34

## brightness system keys 32, 34, 35

## C

### cable lock

- notebook 13
- port replicator 82

### Caps Lock indicator 30

### cards

- adding memory card 49
- inserting memory card 49
- inserting PC Card 50
- installing memory card 49
- memory card slots 12
- PC Card slot 11
- removing memory card 49
- removing PC Card 50
- replacing memory card 49
- slots 48, 50
- troubleshooting memory card 103
- troubleshooting PC Card 109

### carrying case 21

### CD

- cleaning 86
- drive 44
- inserting 45

- playing audio 46
  - CD drive
    - See DVD drive
  - cellular telephone memory cards 48
  - Certificate of Authenticity 19
  - cleaning
    - audio CD 86
    - case 85
    - CD 86
    - DVD 86
    - keyboard 86
    - LCD panel 86
    - notebook exterior 85
    - notebook screen 86
    - screen 86
  - clicking 39
  - closing unresponsive program 29
  - connecting
    - AC adapter 24
    - external keyboard 32
    - external monitor 53
    - keyboard 32
    - port replicator 80
    - projector 53
    - PS/2 keyboard 78
    - PS/2 mouse 78
  - connections
    - AC-3 digital audio 79
    - audio 11, 79
    - digital audio out 79
    - digital camera 11, 78
    - diskette drive 11
    - docking 16, 76
    - docking station 76
    - Ethernet 14, 79
    - external audio 11, 79
    - external speakers 11, 79
    - flash drive 11
    - headphone 11, 79
    - keyboard 11, 78
    - line in 79
    - microphone 11
    - modem 14, 79
    - monitor (VGA) 14, 53, 78
    - mouse 11, 78
    - network 14, 79
    - parallel 14, 78
    - port replicator 16, 76
    - power 14, 24, 77, 79
    - printer 11, 14, 78
    - projector 14, 53, 78
    - PS/2 78
    - PS/2 keyboard 78
    - PS/2 mouse 78
    - S/PDIF digital audio 79
    - scanner 11, 78
    - speaker 11, 79
    - Toslink digital audio 79
    - USB 11, 78
    - VGA 14, 53, 78
    - Zip drive 11, 78
  - copyright notice 125
  - Customer Service
    - Accounting 114
    - Sales 114
    - Warranty 114
- ## D
- default printer 110
  - digital audio S/PDIF jack 79
  - digital camera
    - USB port 11, 78
  - directional keys 33
  - diskette
    - inserting 47
    - status indicator 30
    - troubleshooting 95
  - diskette drive
    - eject button 47
    - locating 12
    - troubleshooting 95
    - using 47
  - display
    - maintaining 86

- properties 53
- switching 34
- troubleshooting 96
- docking port 16, 76
- docking release latch 76
- documentation
  - Gateway Web site 3
  - help 5
  - Help and Support 5
  - online help 7
  - Using Your Computer 6
- double-clicking 39
- dragging 40
- drivers
  - updating 4
- drives
  - CD 13, 44
  - diskette 12, 47
  - DVD 13, 44
  - DVD/CD-RW 13, 44
  - hard drive 15, 70
  - identifying drive types 44
  - recordable DVD 44
  - replacing hard drive 70
  - status indicators 30
  - troubleshooting 95, 97, 99
  - types 44
- DVD
  - cleaning 86
  - drive 44
  - inserting 45
  - playing 46
  - troubleshooting 97
- DVD drive
  - identifying 44
  - locating 13
  - status indicator 30
  - troubleshooting 97
  - using 44
- DVD/CD-RW drive
  - See DVD drive
- DVD±R/±RW drive

See DVD drive

## E

- electrostatic discharge (ESD) 66
- e-mail button 36
- EmPower power adapter 63
- eSupport
  - getting specifications 20
  - using 4
- Ethernet jack 14, 79
- external audio jack 79
- external monitor 14, 34, 78
- EZ Pad touchpad
  - See touchpad

## F

- fan 14
- faxes
  - troubleshooting 106
- files
  - opening 39
  - troubleshooting 99
- finding
  - Help and Support topics 6
  - specifications 20
- floppy disk
  - See diskette
- Fn key 32, 33, 34
- folders
  - opening 39
- function keys 32, 33

## G

- Gateway
  - eSupport 20
  - model number 16, 18
  - serial number 18, 20
  - Web address 3
  - Web site 3

## H

- hard drive

- bay 15
  - installing 70
  - replacing 70
  - status indicator 30
  - troubleshooting 99
- headphone jack 11, 79
- help
  - button 36
  - online 7
  - using 5
- Help and Support
  - searching 6
  - starting 5
  - using 5
- Hibernate mode 63
- hot-swapping 50

## I

- indicators
  - See* status indicators
- inkjet printer 22
- installing
  - battery 60
  - devices 94
  - hard drive 70
  - memory 67
  - PC Card 50
- Internal wireless label 19
- Internet
  - button 36
  - troubleshooting 101, 105
- IRQ conflicts 94

## J

- jacks
  - See* connections

## K

- Kensington cable lock
  - lock slot 13
  - port replicator 82
- key combinations 34

- keyboard
  - buttons 32
  - cleaning 86
  - connecting 32
  - features 32
  - locating 17
  - PS/2 port 78
  - troubleshooting 102
  - USB port 11, 78
- keys
  - application 32, 33
  - arrow 32, 33
  - battery status 34
  - Break 34
  - brightness 32, 33, 34, 35
  - directional 33
  - Fn 32, 33, 34
  - function 33
  - LCD brightness 33, 35
  - LCD/CRT 34
  - navigation 32, 33
  - Pad Lock 34
  - Pause 34
  - power status 34
  - Scroll Lock 34
  - Standby 34
  - Status 34
  - system 32, 33
  - system key combinations 34
  - toggle display 34
  - volume control 33
  - Windows 32, 33

## L

- label
  - internal wireless 19
  - model number 16
  - serial number 18
  - wireless networking 19
- laser printer 22
- latch
  - battery 15



- docking release 76
- LCD panel release 10
- LCD brightness system keys 33
- LCD panel
  - cleaning 86
  - release latch 10
  - switching display 34
  - troubleshooting 96
- LCD/CRT system key 34
- lights
  - See* status indicators
- line in jack 79
- lock
  - Kensington cable 13

## **M**

- maintenance
  - cleaning 85, 86
  - cleaning notebook screen 86
  - general guidelines 84
  - screen 86
  - virus protection 87
  - Windows Update 90
- memory
  - adding 67
  - bay 15
  - installing 67
  - purchasing 21
  - removing 67
  - replacing 67
  - troubleshooting 103
  - upgrading 67
- memory card reader
  - locating 12
  - memory card types supported 48
  - status indicator 30
  - using 48
- microphone jack 11
- Microsoft Certificate of Authenticity 19
- model number 18
- modem

- jack 14, 79
- troubleshooting 104
- monitor
  - adding external 53
  - cleaning 86
  - color quality 54
  - display properties 53
  - port 14, 78
  - screen resolution 54
- mouse
  - PS/2 port 78
  - troubleshooting 107
  - USB port 11, 78
- moving
  - pointer 39
  - screen objects 40
- MP3 player memory cards 48
- multi-function buttons 17, 36
- multimedia
  - adjusting volume 40
  - creating CD 46
  - creating DVD 46
  - playing CD 46
  - playing DVD 46
  - using CD drive 44
  - using diskette drive 47
  - using DVD drive 44
  - using Windows Media Player 46
- muting sound 35, 40
- My Computer button 36

## **N**

- navigation keys 32, 33
- network
  - jack 14, 79
  - troubleshooting 108
- networking
  - internal wireless label 19
  - turning off wireless network 41
  - turning on wireless network 41
- non-technical support
  - Accounting 114

- Sales 114
- Warranty 114
- Norton Antivirus 87
- numeric keypad
  - status indicator 31
  - using 32

## O

- online help
  - button 36
  - using 5, 7
- opening
  - files 39
  - folders 39
  - LCD panel 10
  - notebook 10
  - programs 39
  - shortcut menu 39

## P

- Pad Lock
  - status indicator 31, 34
  - system key 34
- parallel port 14, 78
- password 108
- pause text scrolling 34
- PC Card
  - adding 50
  - eject button 50
  - inserting 50
  - installing 50
  - removing 50
  - slot 50
  - troubleshooting 109
- PCMCIA card
  - See* PC Card
- PDA memory cards 48
- peripheral devices
  - purchasing 21
- playing
  - audio CD 46
  - DVD 46

- pointer
  - moving 39
- port replicator
  - attaching notebook 80
  - docking port 16, 76
  - release latch 76
  - separating notebook 81
  - using 21, 75
- ports
  - See* connections
- power
  - AC adapter 24, 63
  - automobile/airplane adapter 63
  - battery 29, 56, 58, 59, 60, 62
  - button 17, 34
  - changing modes 63
  - connector 14, 24, 77, 79
  - conserving battery power 62
  - EmPower adapter 63
  - extending battery life 62
  - Hibernate mode 63
  - indicator 10, 28
  - management 55, 62
  - source problems 26
  - Standby mode 28, 63
  - Standby/Resume 34
  - status box 34
  - status indicator 10
  - troubleshooting 109
  - turning off notebook 28
  - turning on notebook 27
- power adapter
  - airplane 21
  - automobile 21
- printer
  - default 110
  - inkjet 22
  - laser 22
  - parallel port 14, 78
  - troubleshooting 109
  - USB port 11, 78
- programs

- closing unresponsive 29
- opening 39

projector

- adding 53
- color quality 54
- display properties 53
- screen resolution 54

PS/2 port 78

## R

### RAM

*See* memory

- rebooting notebook 29
- recalibrating battery 59
- recharging battery 58
- recordable DVD drive
  - See* DVD drive
- replacing
  - See* installing
- reset hole
  - location 15
  - using 29
- resetting notebook 29
- restarting notebook 29
- restoring system 90
- right-clicking 39
- rocker switch
  - locating 37
  - using 38

## S

S/PDIF digital audio jack 79

### safety

- caring for notebook 84
- general precautions 116
- guidelines for troubleshooting 92
- static electricity 66

### scanner

- USB port 11

### screen

- cleaning 86

- resolution 54

- troubleshooting 96, 112

### screen objects

- getting information 39
- moving 40
- selecting 39

### Scroll Lock

- status indicator 31, 34
- system key 34

- searching in Help and Support 6

### security features

- Kensington cable lock 13
- Kensington lock ring 82

- serial number 18, 20

### setting up

- safety precautions 116

### shortcut menus

- accessing 39

### shortcuts

- buttons 36
- opening menu 39

- shutting down notebook 28, 29

### SO-DIMM

- See* memory

### sound

- adjusting 35, 40
- controls 33, 40
- muting 35, 40
- troubleshooting 111

### speakers

- built-in 10
- jack 11, 79

### specifications 20

### Standby

- mode 28, 34, 63
- system key 34

### starting

- notebook 27
- programs 39

- static electricity 66

### status indicators

- battery charge 10, 56

- Caps Lock 30
- CD drive 30
- diskette drive 30
- drive activity 30
- DVD drive 30
- DVD/CD-RW drive 30
- hard drive 30
- location 17
- memory card reader 30
- numeric keypad 31, 34
- Pad Lock 31, 34
- power 10
- recordable DVD drive 30
- Scroll Lock 31, 34
- surge protector 26
- Suspend 34
- system identification label 16, 18
- system keys
  - combinations 34
  - key types 33
  - locating 32
- system restore 90

## T

- technical support
  - automated troubleshooting 114
  - eSupport 20
  - Technical Support 114
  - tips before contacting 113
  - tutorial service 114
- telephone support 113
- Toslink digital audio jack 79
- touchpad
  - buttons 37, 38
  - clicking 39
  - double-clicking 39
  - dragging screen objects 40
  - locating 17
  - moving pointer 38, 39
  - moving screen objects 40
  - opening files, folders, and programs 39

- opening shortcut menu 39
- right-clicking 39
- rocker switch 37, 38
- selecting screen objects 39
- troubleshooting 112
- troubleshooting
  - audio 111
  - automated system 114
  - device installation 94
  - diskette drive 95
  - display 96
  - DVD drive 97
  - faxes 106
  - files 99
  - general guidelines 93
  - hard drive 99
  - Internet connection 101, 105
  - IRQ conflict 94
  - keyboard 102
  - LCD panel 96
  - memory 103
  - memory card reader 103
  - modem 104
  - mouse 107
  - network 108
  - passwords 108
  - PC Cards 109
  - power 109
  - printer 109
  - safety guidelines 92
  - screen 96, 112
  - screen area 96
  - screen resolution 96
  - sound 111
  - technical support 113
  - telephone support 113
  - touchpad 112
  - video 112
  - Web site connection speed 102
- turning off
  - notebook 28, 29
  - wireless network 41

- turning on
  - notebook 27
  - wireless network 41

## U

- undocking 81
- updating
  - device drivers 4
  - Norton AntiVirus 87
  - Windows 90
- upgrading 65
- USB port 11, 78

## V

- VGA port 14, 53
- video
  - playing 46
  - troubleshooting 112
- virus
  - protecting against 87
  - removing 87
- volume
  - adjusting 35, 40
  - adjusting modem 107
  - controls 33, 40
  - muting 35, 40
  - system keys 32, 35
  - troubleshooting 111

## W

- waking up notebook 28
- Web browser button 36
- Web site
  - Gateway 3
- Windows
  - key 32, 33
  - Product Key Code 19
  - restoring 90
  - updating 90
- Windows Media Player 46
- Windows Security Center
  - using 87

- wireless network
  - label 19
  - turning off 41
  - turning on 41

## Z

- Zip drive
  - USB port 11





NSK DWL M405 USR GDE R1 09/04



9528974